



modu600-LO

Operating instructions

D100408262

modu600-LO
Operating instructions
D100408262

Contents

Contents	4
Change index	6
1 Preface	7
1.1 modulo 6 I/O modules and the local modu600-LO operation unit.....	7
2 About this manual	8
2.1 Purpose and intended readership	8
2.2 Abbreviations	8
2.3 Symbols and terms used in this manual.....	8
2.4 Firmware version of modu600-LO	9
3 Safety information	10
3.1 Notes on installation	10
3.2 Intended use	10
3.3 Disclaimer	10
3.4 Standards and directives	11
4 Product structure	12
5 Further documentation	13
6 Hardware description	14
7 Functionality and operation	17
7.1 Supported functions.....	17
7.2 Navigation structure.....	18
7.3 State icons	19
7.4 Operation	20
7.5 Views	22
7.6 Settings in CASE	40
8 Maintenance	46
9 FAQ	47
9.1 What happens when LOI and WS/app are used simultaneously?	47
9.2 What does this icon mean?	47
9.3 Which icon is displayed, and when?.....	47
9.4 How can I change the language of the GUI?	48
9.5 How can I update the firmware of the LOI?	48
9.6 What happens with polarity = reverse?	50
9.7 Behaviour of backlight	51
Figures	53
10 Tables	54
11 Annexe	55

Contents

11.1 Didact Gothic – Regular Font Copyright.....55

11.2 Supported characters (Didact Gothic – Regular)58

Change index

R/V	Description	Who	Date
01.02	Market introduction	BOU	Sept. 2019
02.01	Enhancements as of AS firmware Version 1.2.3 New chapters § 9.6, 0	BOU	Mar. 2022
03.01	Update times	BOU	July 2023

Preface**1 Preface****1.1 modulo 6 I/O modules and the local modu600-LO operation unit**

modulo 6 is the latest generation of the SAUTER automation stations for building automation. The **modu680-AS** and **modu660-AS** automation stations and the **modu612-LC** link coupler can be extended using I/O modules to receive various types of signals (inputs) or to drive them (outputs). To better identify the variety of signals in the plant, the I/O modules can be extended using LOIs, i. e. local operation and indication units. These units display the state of the signals, whether an error message applies for this signal or whether an output signal has been manually overridden and is no longer in automatic mode. The LOI unit can be used for local (manual) operation and allows setting output signals manually (override), e.g. during acceptance or maintenance work.

modu600-LO is a universal module for all modulo 6 I/O modules that can be plugged in or off on the modules. The module does not need dedicated programming or configuration and receives all of the necessary information from the I/O module.

modu600-LO offers a graphical overview of all signals and detailed information for every channel, such as the specific configuration (e.g. 0 ...10 V, Digital In etc.) or the assigned house address label. There is also an overview of all the labels in the form of a list. The module also offers general information about the module itself, such as serial number, firmware versions etc., as well as the same information for the connected I/O module.

modu600-LO also temporarily allows wiring or signal tests to be performed on non-configured I/O modules.

2 About this manual

2.1 Purpose and intended readership

This manual is intended for people who use **modu600-LO** to monitor and operate building management systems.

To understand the manual, a certain degree of knowledge of building management, HVAC and control technology is required.

The manual should be kept in a place where it is available at all times for reference.

2.2 Abbreviations

LOI	Local operation and indication
AS	Automation station
I/O	Input/output. Relates to inputs and outputs
DI	Digital input
DO	Digital output
AI	Analogue input
AO	Analogue output
UI	Universal input
UO	Universal output
BI	Binary input
BO	Binary output
MI	Multi-state input
MO	Multi-state output
CI	Counter input
OC	Open collector
PC	Pulse counter

2.3 Symbols and terms used in this manual



Information



Note



Weblink



Factory settings

About this manual**2.4 Firmware version of modu600-LO****2.4.1 Firmware changes**

LOI FW version	Change	Distributed with AS FW	Distribution date
0.12.148 R	First official release	1.0.0	Sept. 2019
0.13.172 R	New firmware version	1.2.0	Sept. 2020
1.0.178 R	New firmware version. Changes in operating principles.	1.2.3	Mar. 2022
1.3.1 R	Analogue outputs in %	1.3.0	July 2022

3 Safety information

Warning



The local operating level is not suitable as an emergency operating level according to machine directive 2006/42/EU. The standard EN ISO 13849-1 was not considered. If necessary, this must be done on the system side.



Local Control units can thus lose their function (signal override) and pose a danger. This must be taken into account in the risk analyses of the systems.

3.1 Notes on installation

modu600-LO is hot-plug-capable and can be connected to any modu6** I/O module. The module automatically reads the information from the I/O module and refreshes the displayed content.

The firmware of the **modu600-LO** is only updated upon restart, if necessary. The **modu600-LO** should not be unplugged during this phase. More on this in § 9.5.

→ **No application to means of transport.**



Unsuitable as measuring instrument according to the EU Measuring Instruments Directive 2014/32/EU, and Regulation 37/2005.

3.2 Intended use

modu600-LO may only be used for the functions described in this manual.

Any improper use can cause malfunctions or damage to the building management system.

Improper operation can cause the recorded data or the entire program of **modu600-LO** to be irretrievably lost.

Unauthorised hardware and software modifications are considered to be violations of the intended use.

Do not use them in the open or in places where condensation can occur.

Access security:

Access to the local operating level (incl. via apps) must be restricted on site.

3.3 Disclaimer

Fr. Sauter AG accepts no liability for any damage caused by improper use of **modu600-LO**. This applies to damage to **modu600-LO** and the associated hardware and software, to building management systems and also for any consequential damage.

Safety information

3.4 Standards and directives

Type of protection		IP30 (EN 60730-1)
Protection class		III (EN 60730-1)
Environment class		3K3 (IEC 60721)
CE conformity according to	EMC Directive 2014/30/EU	EN 61000-6-1 EN 61000-6-2 EN 61000-6-3 EN 61000-6-4 EN 50491-5-1 EN 50491-5-2 EN 50491-5-3

4 Product structure

This product is classified under building management system, in the section “HVAC automation modulo 6”.

91,141	EY6LO00F001	Local operating and indicating unit for I/O module	modu600-LO
---------------	-------------	--	------------

Compatible with:

91,111	EY6IO30F001	16x DI/CI inputs, I/O module	modu630-IO
91,116	EY6IO31F001	8x UI (DI/CI/AI) + 8x DI/CI, I/O module	modu631-IO
91,121	EY6IO50F001	6x relay (2A) outputs, I/O module	modu650-IO
91,126	EY6IO70F001	8x DI/CI/DO (OC) + 8x DI/CI, I/O module	modu670-IO
91,131	EY6IO71F001	8x AO + 8x DI/CI, I/O module	modu671-IO
91,136	EY6IO72F001	4x (AO, DO(OC), UI (DI/CI/AI)) I/O module	modu672-IO ¹

¹ Planned for 2023

Further documentation

5 Further documentation

MV	P100018024
MD	DE: D100489815
	FR: D100490791
	EN: D100490789
PDS	DE: D100380638
	FR: D100380639
	EN: D100380640

6 Hardware description

General properties



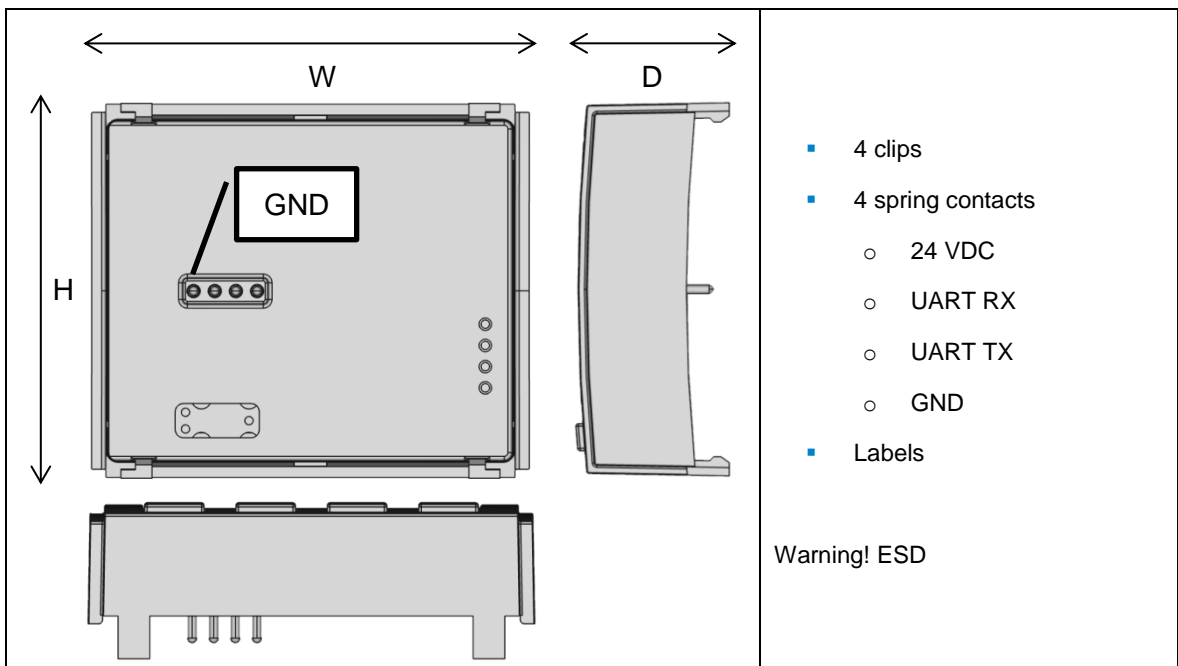

Width	52.5 mm (3 HP)
Height	57.0 mm
Depth	43.5 mm, incl. clips
	41.67 mm, without clips
Protection	IP00

Back

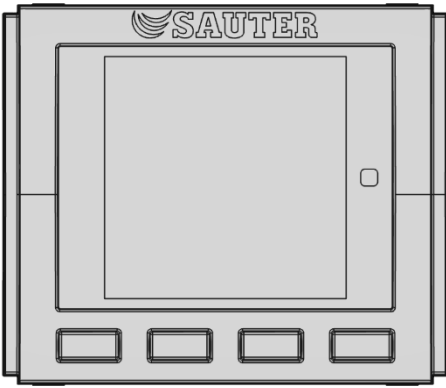

Hardware description

Front

	<p>LOGO</p> <p>LCD colour screen</p> <ul style="list-style-type: none"> ▪ 240 x 240 pixels ▪ 1.44 inches ▪ 25.8 x 25.8 mm² <p>LED</p> <ul style="list-style-type: none"> ▪ Colour coding like I/O module <p>Buttons</p> <ul style="list-style-type: none"> ▪ Cancel, back  ▪ Back, smaller  ▪ Forward, bigger  ▪ Confirm, select 
---	---

Installation instructions

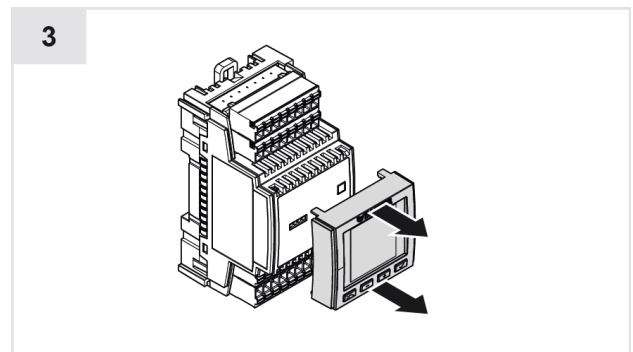
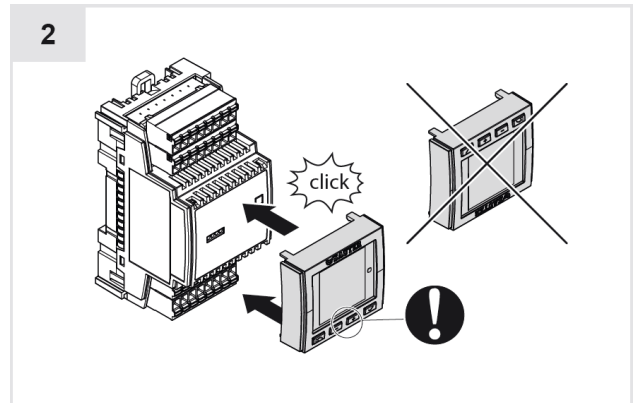
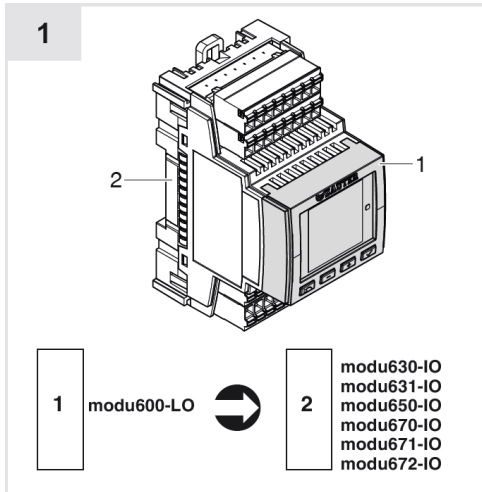

Functionality and operation

7 Functionality and operation

7.1 Supported functions

modu600-LO is used to display and override signals on a modulo 6 I/O module. The following properties are supported:

- Automatic transfer of the state of the I/O module
- Display of the state of the I/O module via LED
- Override of output signals (local operation, manual operation)
- Reset of overridden outputs (AUTO mode)
- Graphical display of the values of all I/O
- Graphical display of special states (alarm, override) based on the associated BACnet object
- List-display of the I/O labels as per engineering
- Graphical detailed view of individual I/O
- Live chart of the signals
- Use of unoccupied I/O
- Keeping the local operation after the station is switched off (stand-alone with **modu601-LC**)
- Default value possible in the stand-alone state (if configured)
- Backlight automatically dimmed (ECO mode)
- SAUTER logo when booting
- Firmware updated automatically from the station (upon reboot only)
- Compatibility with all modu6** I/O modules



Important information

modu600-LO operates at Hardware (field) level, while BACnet represents the application (automation) level. Hence, local (**modu600-LO**², modulo 6 App) overrides have priority over all other systems that can drive the output signals. In the case of BACnet Objects, they identify the overridden status and set the status flag property "override" to TRUE. Any value set to the priority array, e. g. AUTO mode (for SAUTER, priority 16) or manual operation over BMS (usually priority 8) is ignored, as long as a **modu600-LO** or modulo 6 App override is active.

² From firmware version 1.2.3 and the associated **modu600-LO** and modulo 6 app versions, the **modu600-LO** and modulo 6 app are regulated according to the last-wins principle.

7.2 Navigation structure

The following navigation structure is supported by **modu600-LO**. The number of detailed views depends on the number of I/O channels in the I/O module. There are usually 16 channels per module, except for modu650-IO with 6 channels and modu672-IO with 12 channels. **modu600-LO** reads the necessary information from the module when it is plugged in and supplied with power and it automatically adjusts the structure.

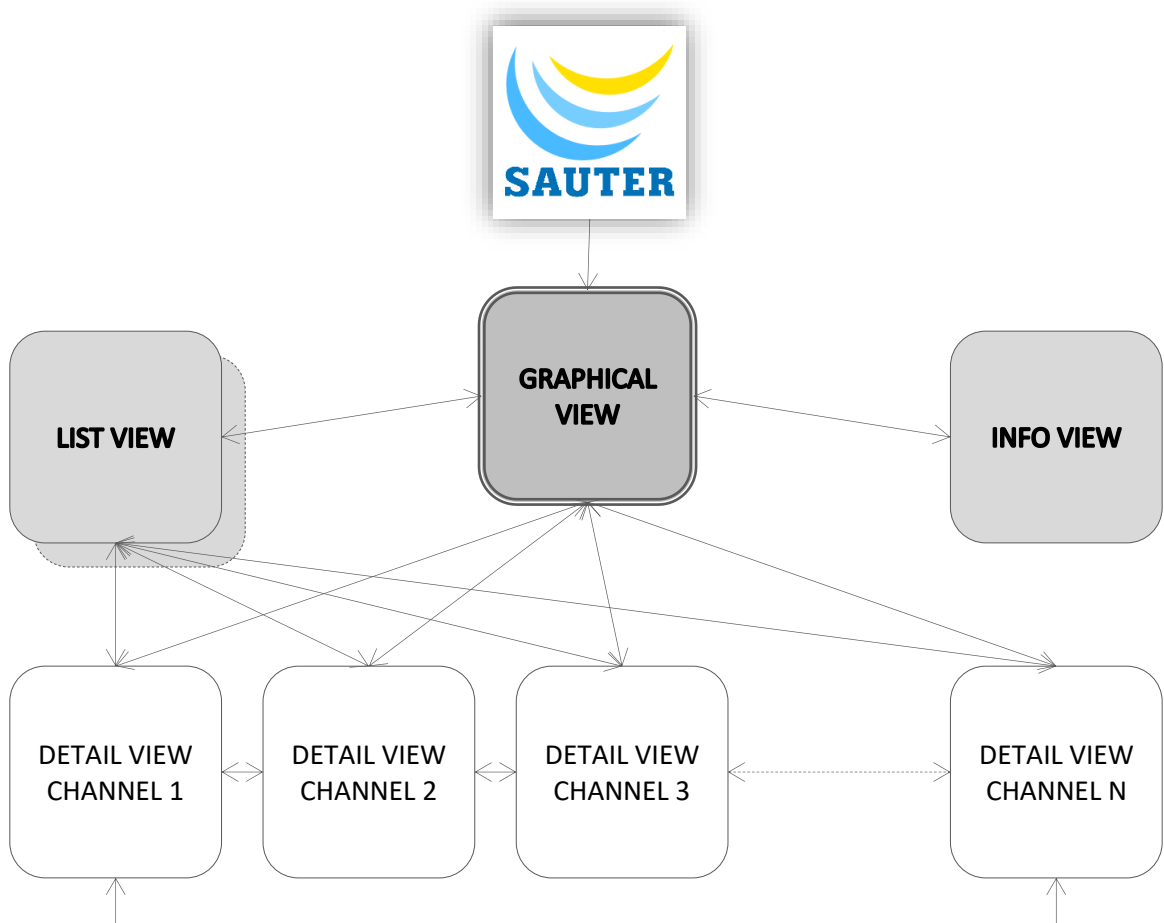







Figure 1 Schema of the different views in modu600-LO and the navigation between the views

Functionality and operation



7.3 State icons

The state icons map the state of the BACnet object that is coupled with this channel. Thus, a non-configured channel does not get any of the BACnet state icons.





	Offline	BACnet object not accessible
	Out of Service	BACnet object in out-of-service mode
	Overridden	BACnet object overridden
	Normal Normal not Ack	BACnet object in a normal state or with events to be acknowledged
	Fault Fault Ack Fault not Ack	BACnet object in a fault state or with acknowledged or unacknowledged event
	Alarm Alarm Ack Alarm, not Ack	BACnet object in alarm state or with acknowledged or unacknowledged event



(see also § 9.3 Which icon is displayed, and when?)

Other icons that are BACnet-independent.



	Label	Label of the BACnet object
	Secure Value	Secure value active
	Reset LOI Override	Reset of the local (manual) operation (override)

7.4 Operation



The operation takes place using the 4 push buttons. The  and  push buttons are used to switch the focus between the different active buttons or change an output value (in edit mode). The  push-button confirms a selection or a value change or displays a new view. The  push-button has the opposite effect.

Push-button	Function(s)
	<p><u>On the overview page:</u></p> <p>If the focus is set on the central text field, when the button is held down (>3 sec.) the info view is displayed.</p> <p>If the focus is set to a channel that is overridden, a long press (>3 sec.) will remove the override.</p> <p><u>Other views:</u></p> <p>When the button is pressed you navigate back to the overview page.</p> <p>In Edit mode, value changes are ignored and the mode is exited.</p>
	<p><u>On the overview page:</u></p> <p>If the focus is set on the central text field, when the button is held down (>3 sec.) the list view is displayed.</p> <p>If the focus is set on any channel, when the button is held down (>3 sec.) the detailed view of the channel is displayed. When the button is pressed briefly, the edit mode for output signals is switched on. The edit mode is indicated by the additional orange font. When pressed again, the new output value is confirmed and the edit mode is exited.</p> <p>In both cases, the focussed state can be identified by its blue frame and a slightly darker background.</p> <p><u>In the detailed view:</u></p> <p>If the focus is set on an editable field, the frame colour is orange and the button is pressed briefly to switch the edit mode on. </p> <p>Additionally, it is also possible to change the channel configuration of the channels that are not assigned with the CASE Engine plan. For example, a non-configured UI channel can be changed to 0 ... 10 V, 0 ... 20 mA etc. This local configuration is not saved and will be lost in case of power failure or removal of the LOI.</p> <p><u>In the list view:</u></p> <p>When the button is pressed the detailed view of the focussed channel is displayed.</p>

Functionality and operation

Push-button	Function(s)
 	<p><u>On the overview page:</u></p> <p>This button is used to change the focus from the central text field to the next channel, forwards or backwards.</p> <p>If a channel is in edit mode, the value is changed using the buttons. For analogue values, the standard step is 1/1000 of the dynamic range (0.01 V for 0...10 V). When the button is held down, the step is increased in size to make a bigger value change faster.</p> <p><u>In the info view:</u></p> <p>The buttons are used to switch between the two views (tabs).</p> <p><u>In the list view:</u></p> <p>The buttons are used to set the focus on the channels one after the other. If not all channels can be displayed in the list, they are spread over different pages. For example, the modules with 16 channels are spread over 2 pages. The switch is made automatically when the button is pressed once more after the last or first channel on a page has been reached.</p>

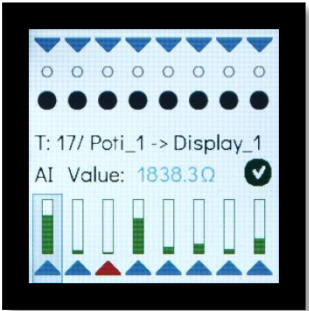
7.5 Views

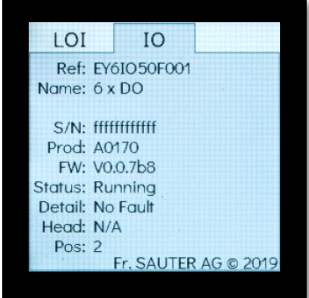
	<p>Boot</p> <p>Is displayed while modu600-LO is starting up.</p>
	<p>Overview, standard view</p> <p>This is the standard view. It displays all I/O signals graphically. It is displayed after the start-up and after the configured time-out period.</p>
	<p>List view</p> <p>The list view shows all I/O channels with the labels defined in the project.</p> <p>If there are 16 I/O modules the list is spread over 2 pages.</p> <p>If there are 6 I/O modules the list is displayed on 1 page.</p> <p>Long texts are scrolled when selected.</p>
	<p>Info view</p> <p>The info view contains up to three tabs.</p> <p>The "LOI" tab displays various information for modu600-LO such as serial number, production date, firmware version etc.</p> <p>The "IO" tab displays the same information on the I/O module on which modu600-LO is located. Thus, it is not necessary to remove modu600-LO and the modu6** I/O module to read this information.</p> <p>The "OVR" tab only appears when output signals are overridden. It allows resetting all overloaded signals on the host module with a long (> 3 s. press of a button.</p>

Functionality and operation

	<p>Detailed view</p> <p>The detailed view offers further information for a selected I/O channel. The view shows how the channel has been configured by the project, with a label, signal type and value.</p> <p>This view allows to manually configure unused channels.</p>
	<p>Black with LED red</p> <p>During the firmware update, the screen remains black and the LED blinks red (see § 9.5).</p>

7.5.1 Overview page

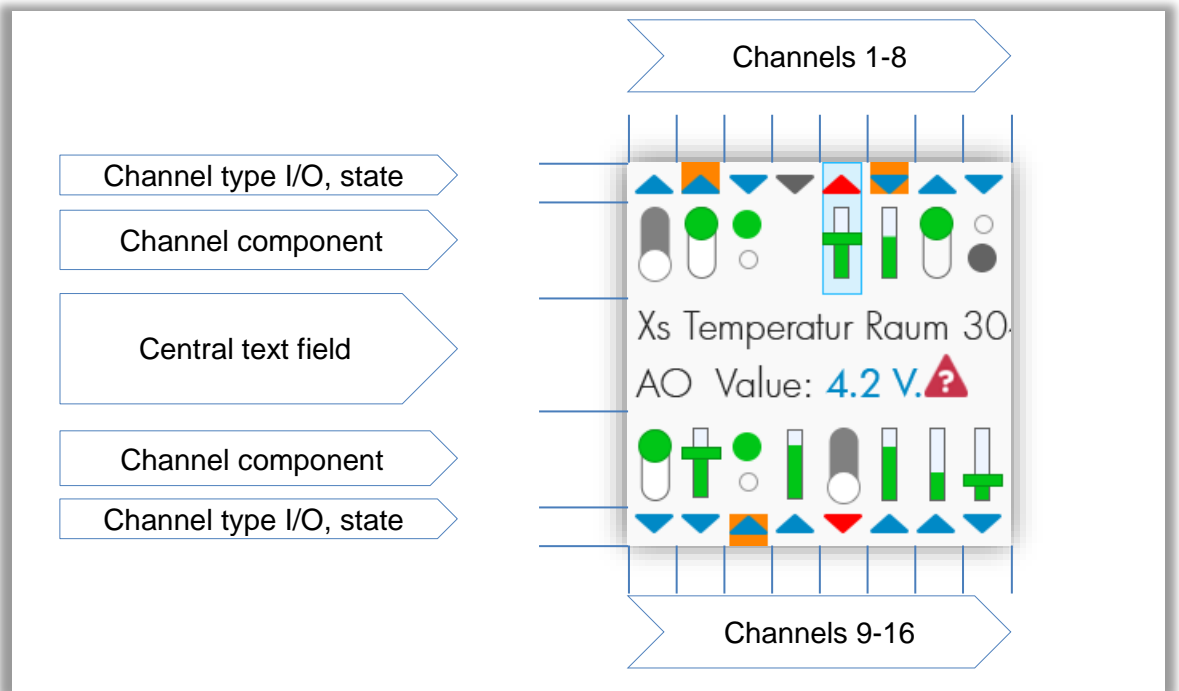





Figure 2 Areas in the overview

Channel type area



The triangles show whether the channels are inputs or outputs, whether configured (blue instead of grey) and whether in alarm state (red). The orange background colour indicates that the related signal is in manual mode (overridden).

Blue:	Configured	
Grey:	Not configured	
Red:	Alarm (flashing):	
Orange:	Manual	
Input:	"Inwards"	
Output:	"Outwards"	

Signal component area

The components differ by signal type between digital (LED, switch) and analogue signals (bar, slider) and between active (green) and not active (grey). The components show the current value in graphical form, either as IN/OUT or on a relative scale.

If, for example, the focus is set to a channel, a dark blue background with a thin frame is shown behind the component. If a multi-state BACnet object is occupying multiple digital channels, all of the affected channels are highlighted with this background.

Output channels can be controlled directly from the overview page. When the button  is pressed briefly when the focus is set to an output channel, the value is highlighted in the central text field area (darker background, frame, orange font) and can be changed. The change must be validated (button ) or rejected (button .

Non-configured channels are identified by a grey triangle and the absence of the component.

Central text field area

The central text field displays the most important information for the channels and the I/O module. For this, the focus must be set on one of the channels or on the text field itself.

Focus on the text field (default):

The reference of the I/O module is displayed: EY6IOxxF001

When the  button is held down the list view is displayed.

When the  button is held down the info view is displayed.

Functionality and operation

Focus on a channel:

For configured channels, the defined label is displayed on the first line. If this text is longer than the available space it is displayed as a running text.

Details are displayed on the second line:

- Object type: AI, AO, BI, BO, CI, MI, MO
- Value³: Interface Value⁴; with unit for analog values as of plan. (Fallback: effective measured value. For analogue values, unit included (V, mA, Ω))
- Object state (see § 7.3)

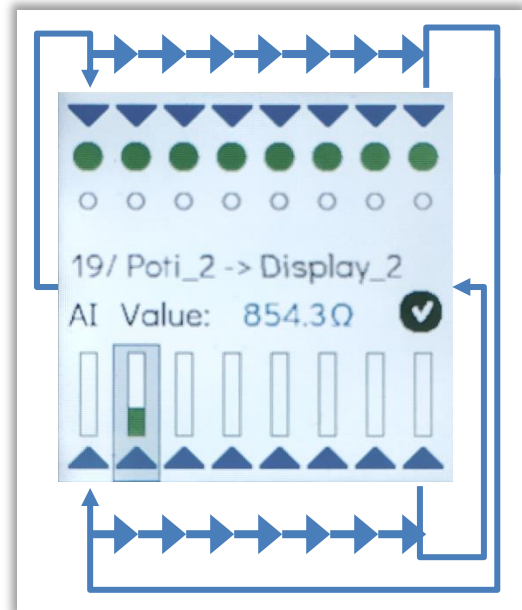

³ With AS-FW v1.2.3 and LO-FW 1.0.178

⁴ BACnet object property, identical to Present Value under normal situation

Functionality and operation

Obj.	Icons	Value	Line 2		
BI		The bottom circle stands for:	BI Value:	<i>IAcTxt</i>	State
		OFF, LOW, "0", inactive			
		Top circle, stands for:	BI Value:	<i>AcTxt</i>	State
		ON, HIGH, "1", active			
BO		The white circle in the bottom position, grey background. Stands for OFF, LOW, "0", inactive.	BO Value:	<i>IAcTxt</i>	State
		The green circle in the top position, white background. Stands for ON, HIGH, "1", active.	BO Value:	<i>AcTxt</i>	State
MI		Multiple BI	MI Value:	<i>StateText[n]</i>	State
MO		Multiple BO	MO Value:	<i>StateText[n]</i>	State
AI		Vertical bar. The height of the bar corresponds to the relative value in the supported area.	AI Value:	<i>Input Value Unit</i>	State
AO		The height of the bar and the slider corresponding to the relative value in the supported area.	AO Value:	Output value <i>Unit</i> ⁵	State

Table 1 Summary of the signal components and the central text field based on signal type and BACnet object

Non-configured channels

Non-configured channels are displayed with a grey triangle. The signal components are not displayed and when the focus is on the channel no texts or values are visible. However, in the detailed view, it is possible to set a channel and thus receive or set signals.

⁵ Default %. Fallback: V, mA.

Functionality and operation

7.5.2 List view

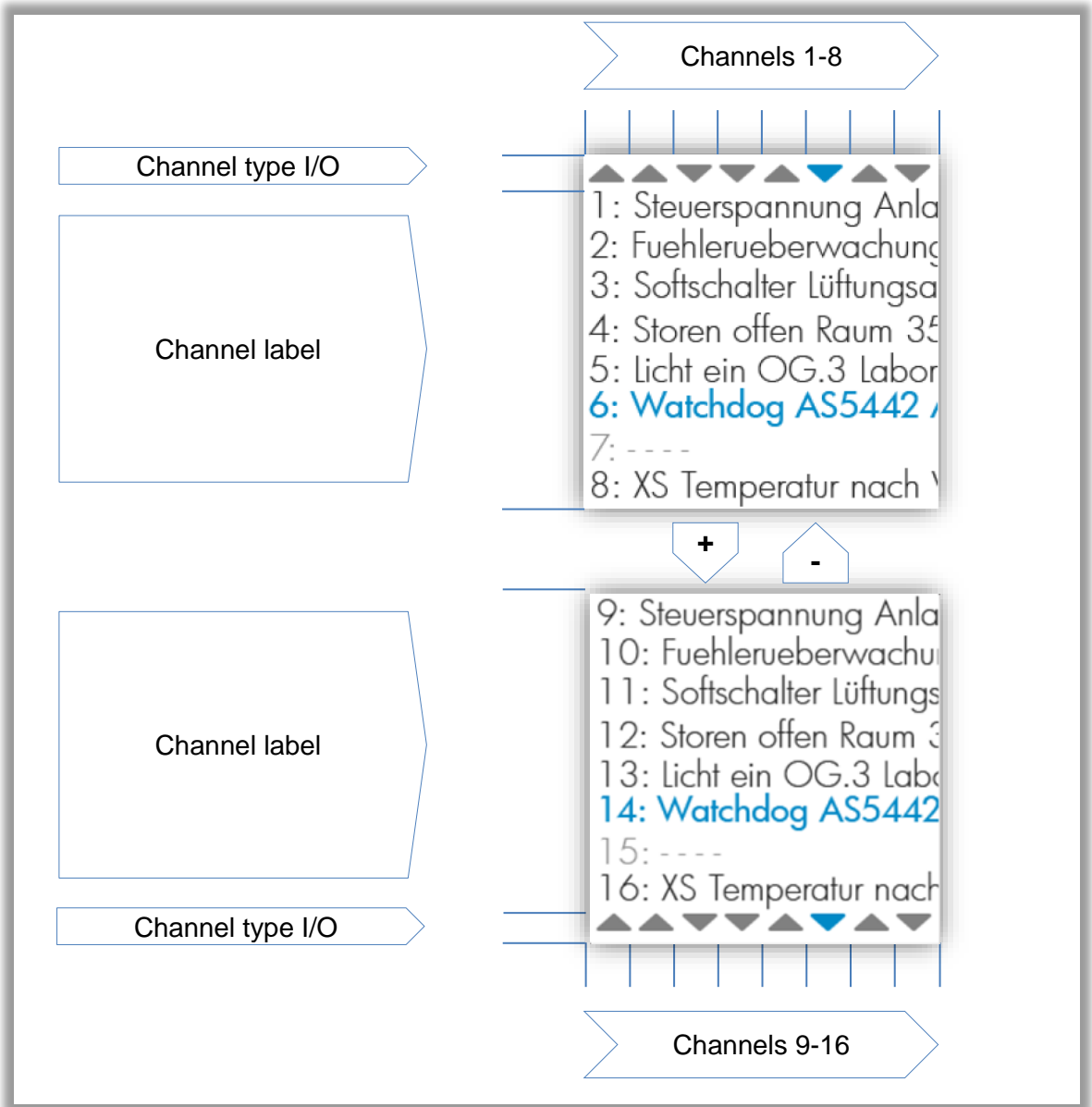





Figure 3 Areas in the list view

Channel type area

The triangles show whether the channels are inputs or outputs. The **+** and **-** buttons change the focus, which is indicated by the blue colour.

Channel label source

This area displays the channels with their number and the configured label. Non-configured channels do not have labels. The  and  buttons change the focus, which is indicated by the blue text colour.

When the  button is pressed the detailed view of the selected channel is displayed.

When the  button is pressed the list view is closed and the overview page is displayed.

Functionality and operation

7.5.3 Detailed view

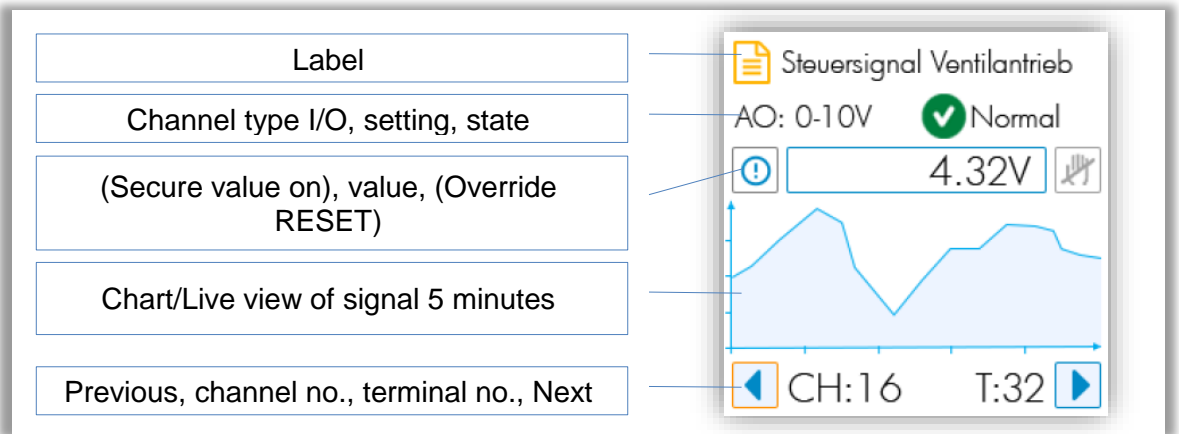

Figure 4 Areas in the detailed view

Label area

For configured channels, the label corresponds to the definition created in CASE Engine. This area is empty for non-configured channels.

Channel type area

For configured channels, the supported configuration is displayed here as well as the state of the assigned object.

For non-configured channels, no state is displayed (no assigned BACnet object) and the channel configuration is an active field that can be operated. For this, you have to:

1. Set the focus to the field (and buttons)
2. Switch the field to the edit mode
3. Use the and buttons to make a selection from the list, then validate with .

Channel type	DI/CI	DI/CI/DO_OC	DO_R	UI	AO	UO
Selection (BACnet object)	Digital In (BI, MI)	Digital In (BI, MI)	Digital Out (BO, MO)	0 (2)... 10 V	0 (2)... 10 V	0 (2)... 10 V
	Counter In (PC)	Counter In (PC)		Ni1000		0 ... 20 mA
		Digital Out (BO, MO)		Pt1000		
				R <2500 Ω		
				----- 0 (4)... 20 mA		
			Pot			

Table 2 Configuration options based on channel type

Value area



In this area, the effective value is normally displayed.

In the case of a binary or multi-state configuration, the logical value is displayed or, if it exists, the text defined in the BACnet object (IAcTxt, AcTxt, StTxt).

From firmware version 1.2.3 onwards on the automation stations, the configured unit from the assigned BACnet object is indicated for Analogue values, as well as the calculated value instead of the measured value. If the automation station fails or the channels are not configured, the measured value is displayed with the corresponding physical unit:

- 0(2) ... 10 V → V
- 0(4) ... 20 mA → mA
- Ni1000 → Ω
- Pt1000 → Ω
- R <2500 Ω → Ω

The  icon indicates that the security value defined in CASE Engine is active. This applies only if the station is no longer communicating with the module (absent, fault, download ...). Normally this icon is not displayed.

The  icon indicates that the output signal has been overridden, via either LOI or app. The icon is also a button that can be focussed. In this case, when the  button is pressed the override is applied and the channel is reset to the AUTO mode (according to the plan).



Important information

For binary and multi-state objects, the state texts are limited to 16 bytes. Depending on the character, 1 to 4 bytes are required per character. In the detailed view, at least 9 characters are visible in the value field.

Functionality and operation

Chart area



This area graphically displays the development of the value over the last 5 minutes.



Important note

The sampling is performed approx. every 1.5 seconds. Because the cycle time of the station can be as low as 50 ms, this display and the measurement cannot be viewed as a precision measurement or as evidence.

Navigation area

This area contains two buttons  . Focussing them and pressing the  button navigates to the next or previous detailed view.

The channel number **CH: ##** $\in [1 \dots 16]$ and the terminal number **T: ##** $\in [1 \dots 32]$ are also displayed in this area.

Non-configured channels

It is easy to identify the non-configured detailed view. The “Label”, “Value” and “Channel definition” areas are empty. Only the signal type is labelled with “unused”.

This field can be focussed and, depending on the channel type, the existing configuration options are displayed.

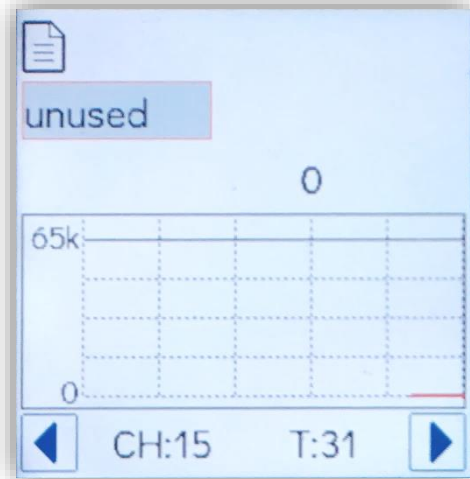

Digital signals

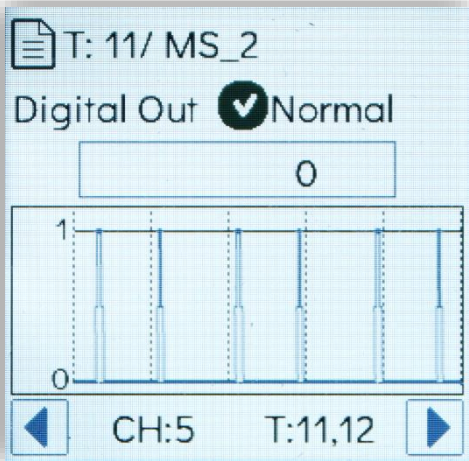
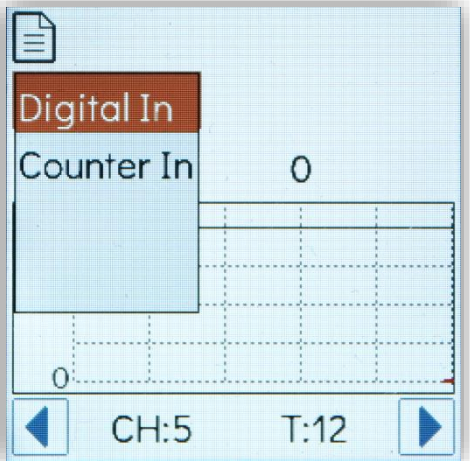
Input configured	Input not configured
<p>Digital Input</p> 	
<p>Value: The state will be displayed with the IAcTxt/AcTxt texts of the associated BACnet object (default 0/1). If it is configured as a counter, "Cnt" is displayed after the value.</p> <p>Chart: 2 levels</p>	<p>The non-configured channel is indicated as "unused". The label and state are empty. Security value and AUTO mode are also not relevant.</p> <p>DI/CI channels can be configured as:</p> <ul style="list-style-type: none"> ▪ Digital In ▪ Counter In <p>The selection appears after focussing and validation. Select using the - and + buttons and validate ✓ or cancel ↶.</p>

Functionality and operation

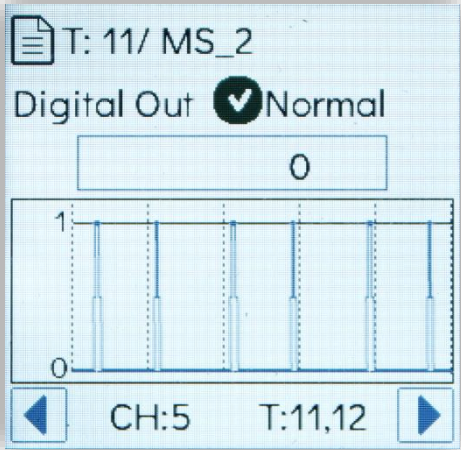
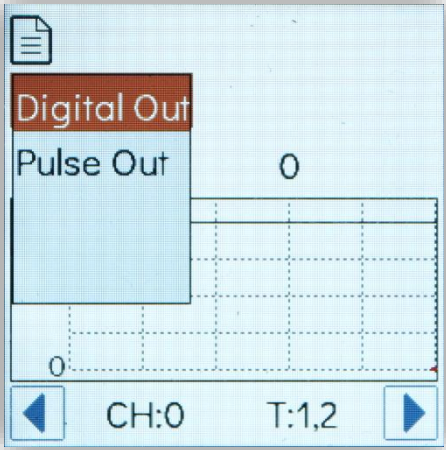
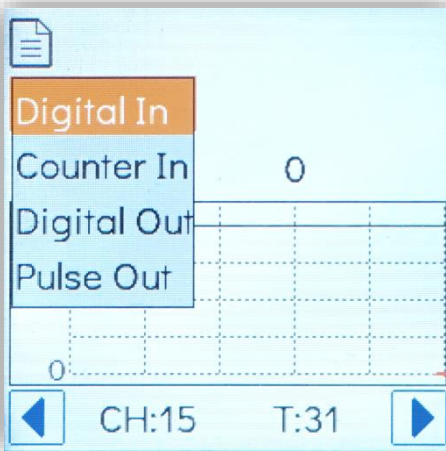
Output configured	Output not configured
<p>Digital Output</p> 	<p>Digital Output (Relay, DO_R)</p>  <p>Digital Output (Open Collector, DO_OC)</p> 
<p>The - and + buttons can be used to set the focus to the value field, and the ✓ button puts it into the edit mode.</p> <p>After focussing, the value can be changed using the - and + buttons.</p> <p>A value change can be validated or rejected using the ✓ and ↶ buttons.</p> <p>The ✎ button appears if the value has been overridden manually. After you focus on this button and validate using the ✓ button, the AUTO mode is reset.</p>	<p>The non-configured channel is indicated as “unused”. The label and state are empty. Security value and AUTO mode are also not relevant.</p> <p>DO_R and DO_OC channels can be configured as:</p> <ul style="list-style-type: none"> ▪ Digital Out ▪ Pulse Out <p>The selection appears after focussing and validation. Select using the - and + buttons and validate ✓ or cancel ↶.</p>

Analogue signals

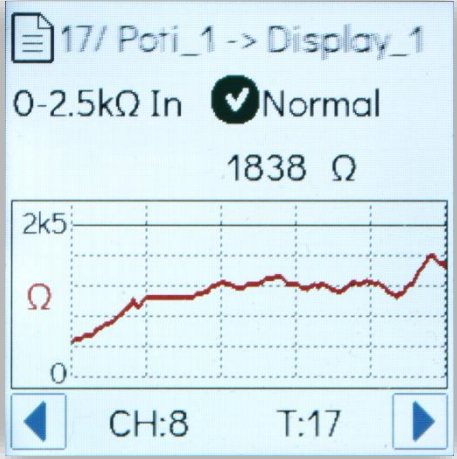
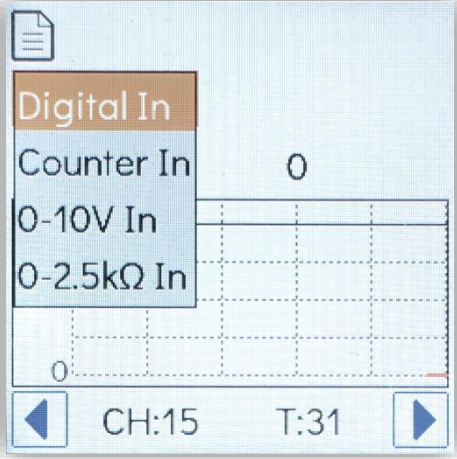
Input configured	Input not configured
	
<p>Value: Interface-Value + Unit (BACnet properties of associated object)</p> <p>Fallback:</p> <ul style="list-style-type: none"> ▪ Setting 0 ... 10 V → Unit V ▪ Setting 0 ... 20 mA → Unit mA ▪ Setting Ni, Pt, R → Unit Ω <p>Chart: Line</p>	<p>Selection modu631-IO:</p> <ul style="list-style-type: none"> ▪ 0–10 V In ▪ 0–2.5 kΩ In ▪ Digital In ▪ Counter In <p>Selection modu672-IO:</p> <ul style="list-style-type: none"> ▪ As with modu631-IO, and ▪ 0 ... 20 mA ▪ Pot <p>The selection appears after focussing and validation. Select using the - and + buttons and validate ✓ or cancel ↶.</p>

Functionality and operation

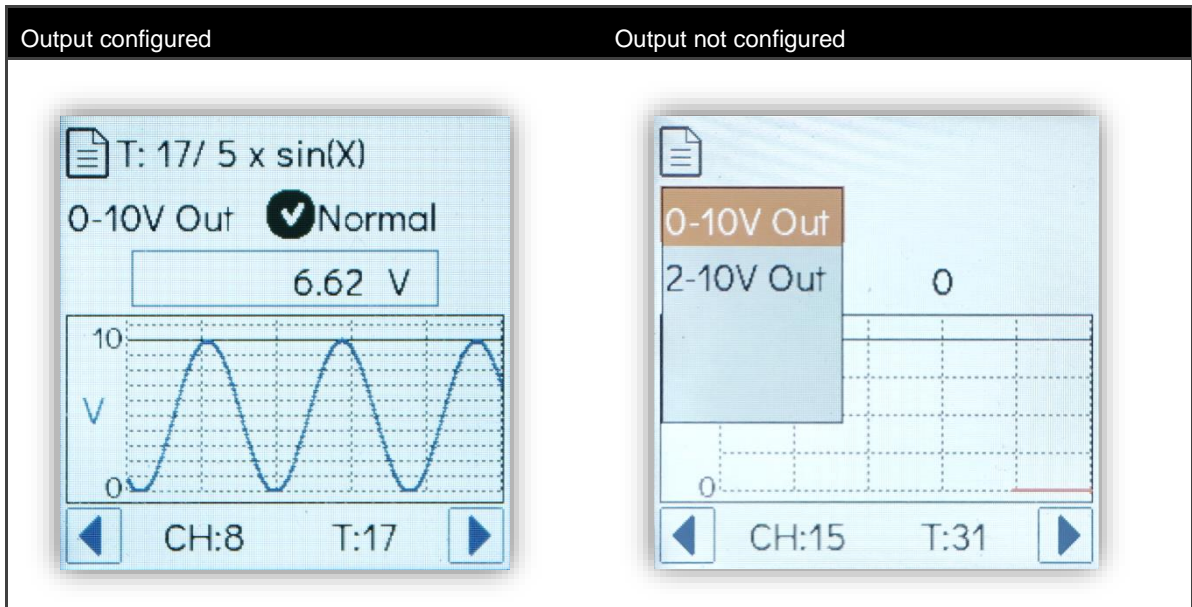

The **-** and **+** buttons can be used to set the focus to the value field, and the button puts it into the edit mode.

After focussing, the value can be changed using the **-** and **+** buttons.

A value change can be validated or rejected using the **✓** and **↶** buttons.

The **👉** button appears if the value has been overridden manually. After you focus on this button and validate using the **✓** button, the AUTO mode is reset.

Analogue outputs can be configured as:

- 0–10 V Out
- 2–10 V Out

The selection appears after focussing and validation. Select using the **-** and **+** buttons and validate **✓** or cancel **↶**.

Ranges of the analogue values

Nominal	0	Max. (nom.)	Peak
0(2) ... 10 V	0(2) V	10 V	11.5 V
0(4) ... 20 mA	0(4) mA	20 mA	22 mA
200 ... 2500 Ω	100 Ω	2.5 kΩ	2700 Ω

Table 3 Nominal and effective ranges of the analogue signals

Representation of the set unit in the BACnet object

BACnet Analogue objects can be configured with a unit, e.g: °C, km, %, etc... The conversion of the measured value in V, mA or Ω into the corresponding value with the unit set in the associated BACnet object takes place in the automation station. This scaling is usually linear, with the exception of the Ni1000 and Pt1000 which are converted with a curve. As long as the connection to the AS is present, this calculated

value and the set unit are displayed on the **modu600-LO**. If the unit is missing or the connection is broken, the unscaled value and unit are displayed.

For analogue outputs (AO), the manual override is only shown as a % of the nominal range.

Hint:

To ensure that the display with the unit is correct, do not forget to configure the signals correctly with CASE Engine. This is particularly relevant when measuring a variable resistance.

Example:

HW Values	Example Value	BACnet Object Parameter	Example Value
Min. HW Value	100 Ω	Min. Present Value (MinPV)	0 %
Max HW Value	2500 Ω	Max Present Value (MaxPV)	100 %

From this one calculates:

$$slope = \frac{(MaxPV - MinPV)}{(MaxHW - MinHW)} = \frac{(100 - 0)}{(2500 - 100)} = 0.04167$$

$$offset = MinPV - slope \times MinHW = 0 - 0.04167 \times 100 = -4.167$$

These parameters slope and offset must be entered in the signal configuration. This setting is valid while the values used for calculation remain unchanged, e.g. MinPV or MaxPV.

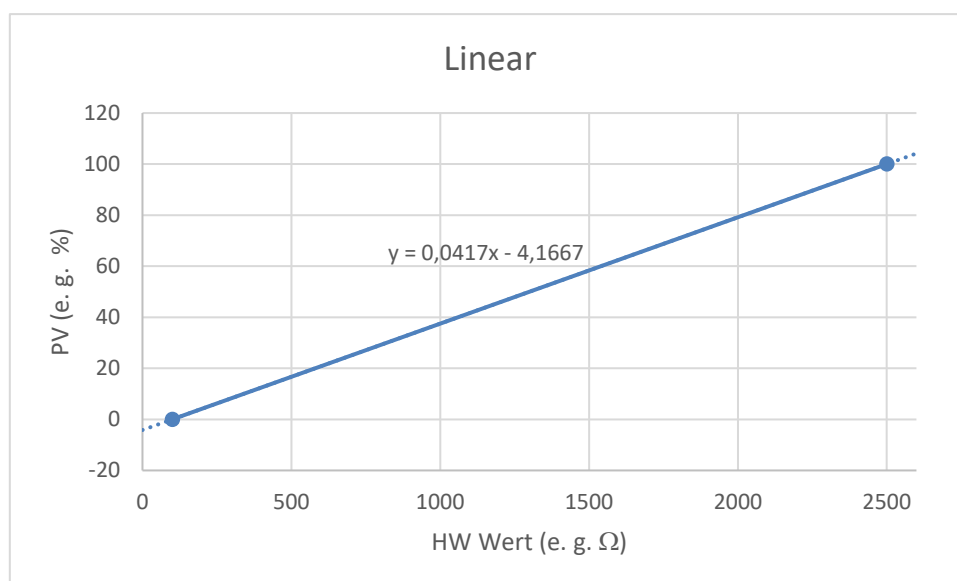

Functionality and operation

Multi-state signals

Multi-state signals are combinations of digital signals that have been assigned to a single multi-state BACnet object. For this reason, there are no unconfigured multi-states.

Input configured	Input not configured
<p>Detailed view per multi-state</p> <p>Value is one of the StateText[i] texts of the associated BACnet object.</p> <p>Chart: Step</p>	<p>Not present</p>
Output configured	Output not configured
<p>A manual setting is made using the multi-state steps and not via the individual digital signals.</p>	<p>Not present</p>



Important information

Multi-state BACnet objects in modulo 6 can define up to 8 states. **modu600-LO** can display up to 4 steps or states as multi-state. In comparison, it was only possible to control 2 channels with modu650F002 (0 – I – II).

8 multi-states are possible with each **modu600-LO**.

The state texts are limited to 16 bytes. Depending on the character, 1 to 4 bytes are required per character. In the detailed view, at least 9 characters are visible in the value field.

Functionality and operation

7.5.4 Info view

<p>LOI info view</p> <p>Reference number: EY6LO00F001</p> <p>Name: Local Operation and Indication Unit</p> <p>Serial number: #####</p> <p>Date of Production: #####</p> <p>Firmware version: v#.#.#b###</p> <p>Copyright: Fr. SAUTER AG © 2019</p>	<p>LOI IO</p> <p>Ref: EY6LO00F001</p> <p>Name: Local Operation and Indication Unit</p> <p>S/N: 000000000032</p> <p>Prod: A1908</p> <p>FW: V0.8.126 R</p> <p>Fr. SAUTER AG © 2019</p>
<p>I/O module info view</p> <p>Reference number: EY6IO**F001</p> <p>Name:</p> <p>Serial number: #####</p> <p>Date of Production: #####</p> <p>Firmware version: v#.#.#b###</p> <p>Operating status: #</p> <p>Detailed info: #</p> <p>Station: EY6AS##F0#1</p> <p>Position: ##</p> <p>Copyright: Fr. SAUTER AG © 2019</p>	<p>LOI IO</p> <p>Ref: EY6IO50F001</p> <p>Name: 6 x DO</p> <p>S/N: ffffffff</p> <p>Prod: A0170</p> <p>FW: V0.0.7b8</p> <p>Status: Running</p> <p>Detail: No Fault</p> <p>Head: N/A</p> <p>Pos: 2</p> <p>Fr. SAUTER AG © 2019</p>
<p>OVR</p> <p>Remove all overrides of the module</p> <p>(Appears only when Overrides are present)</p>	<p>LOI IO OVR</p> <p>Do you want to remove all overrides?</p>  <p>Fr. SAUTER AG © 2019</p>

7.6 Settings in CASE

The following settings in CASE affect the display and functionality of **modu600-LO**:

7.6.1 States in binary and multi-state objects

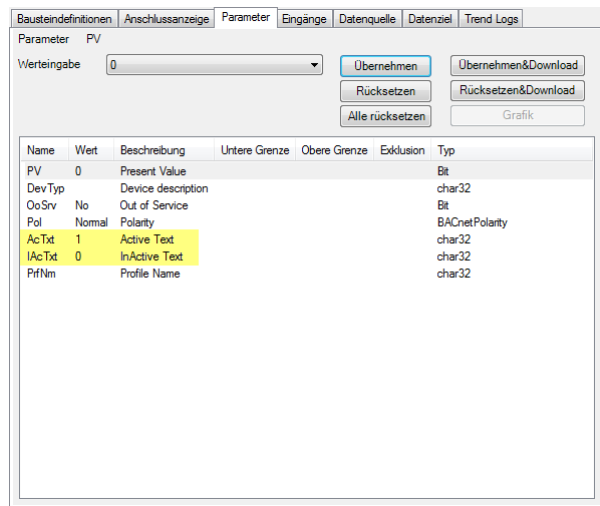
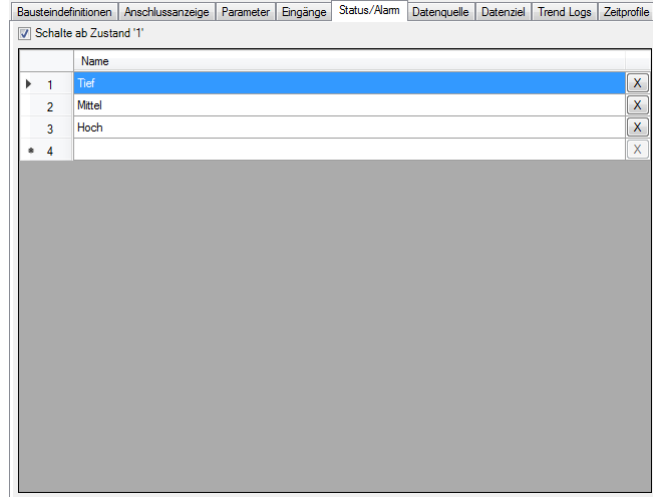
 <table border="1"> <thead> <tr> <th>Name</th> <th>Wert</th> <th>Beschreibung</th> <th>Untere Grenze</th> <th>Obere Grenze</th> <th>Exklusion</th> <th>Typ</th> </tr> </thead> <tbody> <tr> <td>PV</td> <td>0</td> <td>Present Value</td> <td></td> <td></td> <td></td> <td>Bit</td> </tr> <tr> <td>DevTyp</td> <td></td> <td>Device description</td> <td></td> <td></td> <td></td> <td>char32</td> </tr> <tr> <td>OoSrv</td> <td>No</td> <td>Out of Service</td> <td></td> <td></td> <td></td> <td>Bit</td> </tr> <tr> <td>Pol</td> <td>Normal</td> <td>Polarity</td> <td></td> <td></td> <td></td> <td>BACnetPolarity</td> </tr> <tr> <td>AcTxt</td> <td>1</td> <td>Active Text</td> <td></td> <td></td> <td></td> <td>char32</td> </tr> <tr> <td>IAcTxt</td> <td>0</td> <td>InActive Text</td> <td></td> <td></td> <td></td> <td>char32</td> </tr> <tr> <td>PfNm</td> <td></td> <td>Profile Name</td> <td></td> <td></td> <td></td> <td>char32</td> </tr> </tbody> </table>	Name	Wert	Beschreibung	Untere Grenze	Obere Grenze	Exklusion	Typ	PV	0	Present Value				Bit	DevTyp		Device description				char32	OoSrv	No	Out of Service				Bit	Pol	Normal	Polarity				BACnetPolarity	AcTxt	1	Active Text				char32	IAcTxt	0	InActive Text				char32	PfNm		Profile Name				char32	<p>Binary objects have two text properties that can be used to assign a text for the active or inactive state:</p>
Name	Wert	Beschreibung	Untere Grenze	Obere Grenze	Exklusion	Typ																																																			
PV	0	Present Value				Bit																																																			
DevTyp		Device description				char32																																																			
OoSrv	No	Out of Service				Bit																																																			
Pol	Normal	Polarity				BACnetPolarity																																																			
AcTxt	1	Active Text				char32																																																			
IAcTxt	0	InActive Text				char32																																																			
PfNm		Profile Name				char32																																																			
 <table border="1"> <thead> <tr> <th></th> <th>Name</th> </tr> </thead> <tbody> <tr> <td>1</td> <td>Tief</td> </tr> <tr> <td>2</td> <td>Mittel</td> </tr> <tr> <td>3</td> <td>Hoch</td> </tr> <tr> <td>4</td> <td></td> </tr> </tbody> </table>		Name	1	Tief	2	Mittel	3	Hoch	4		<p>The states of the multi-state objects must be described with corresponding texts. These texts are displayed as "Value" instead of 1, 2, 3 etc.</p>																																														
	Name																																																								
1	Tief																																																								
2	Mittel																																																								
3	Hoch																																																								
4																																																									

7.6.2 Defining the labels of the channels with CASE Engine

The labels of the channels in the LOI are defined in CASE Engine at the station level. There is a new button for this in the context menu of the modulo 6 stations.

Functionality and operation

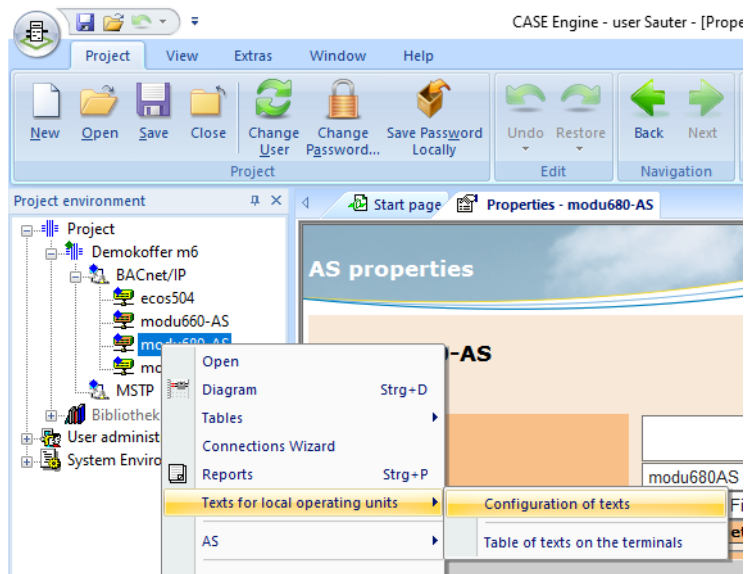

Figure 5 Context menu of a modulo 6 station and path to the LOI label editor

Similarly to the printed labels in modulo 5, the editor is set up in the form of a table. The editor offers a general configuration but also the option of individual configurations based on channel type (AI, AO, BI, BO, MI, MO, CI).

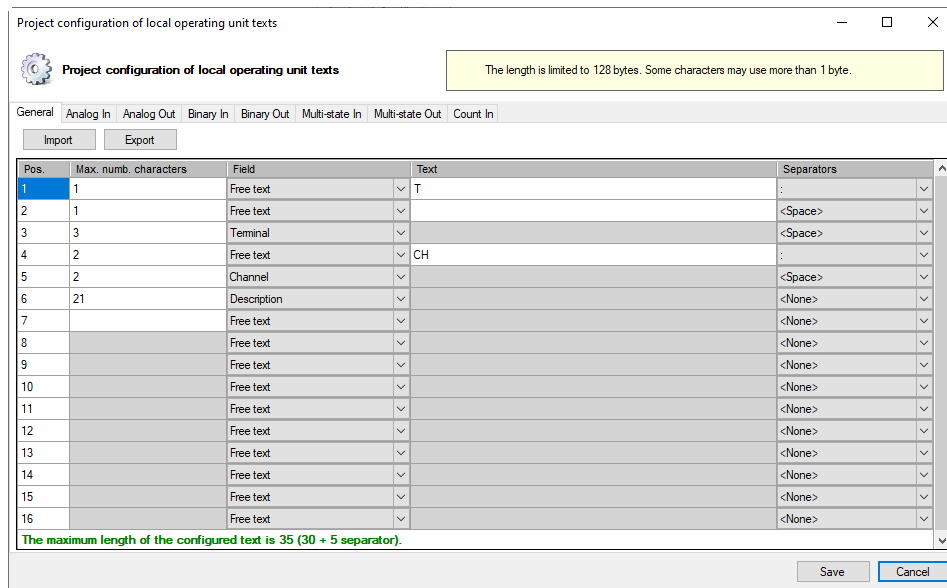

Figure 6 Editor table for general configuration

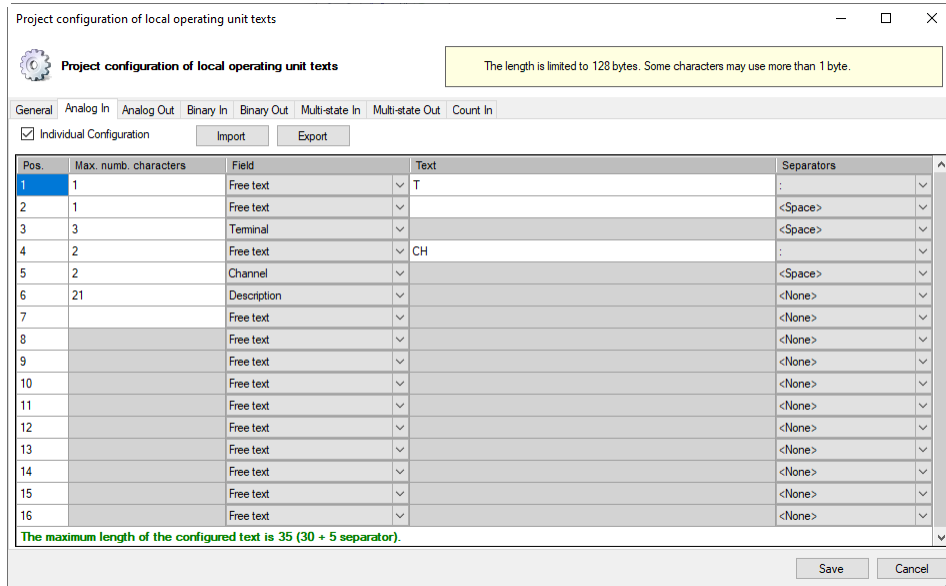

Figure 7 Tab for individual configuration, which is activated via the checkbox

The description is created by combining various fields, with each field having a specific length. The information in the fields is selected from a list and different information from the hardware and the software is available:

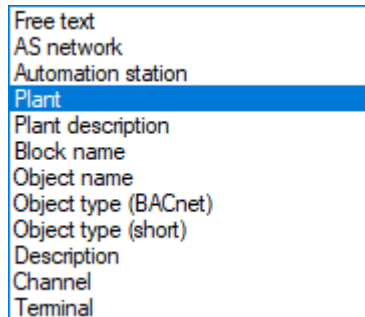

Figure 8 Selection from the “Field” column

The “Table of texts on the terminals” button can be used to see the result of all channels in the “Label” column.

Functionality and operation

Signal name	Signal description	Label individual	Label	Direction	Data type	Blocks
1 (IO-Module) EY6IO71 (1/2)	Switch_1_1 -> LED_Relay_1	<input type="checkbox"/>	T: 1/2 CH:0 Switch_1_1 -> LED_Rel	Source	Binary	BI_1
1 (IO-Module) EY6IO71 (3/4)	Switch_1_2 -> LED_Relay_2	<input type="checkbox"/>	T: 3/4 CH:1 Switch_1_2 -> LED_Rel	Source	Binary	BI_2
1 (IO-Module) EY6IO71 (5/6)	Switch_1_3 -> LED_Relay_3	<input type="checkbox"/>	T: 5/6 CH:2 Switch_1_3 -> LED_Rel	Source	Binary	BI_3
1 (IO-Module) EY6IO71 (7/8)	Switch_1_4 -> LED_Relay_4	<input type="checkbox"/>	T: 7/8 CH:3 Switch_1_4 -> LED_Rel	Source	Binary	BI_4
1 (IO-Module) EY6IO71 (9/10)	Switch_1_5 -> LED_Relay_5	<input type="checkbox"/>	T: 9/1 CH:4 Switch_1_5 -> LED_Rel	Source	Binary	BI_5
1 (IO-Module) EY6IO71 (11/12)	Switch_1_6 -> LED_Relay_6	<input type="checkbox"/>	T: 11/ CH:5 Switch_1_6 -> LED_Rel	Source	Binary	BI_6
1 (IO-Module) modu671IO (13/14)	Multistate_1_788	<input type="checkbox"/>	T: CH: Multistate_1_788	Source	Multi-state (3)	Multistate_1_788
1 (IO-Module) EY6IO71 (17/18)	Display_1	<input type="checkbox"/>	T: 17/ CH:8 Display_1	Target	Analogue	AO_1
1 (IO-Module) EY6IO71 (19/20)	Display_2	<input type="checkbox"/>	T: 19/ CH:9 Display_2	Target	Analogue	AO_2
1 (IO-Module) EY6IO71 (21/22)	Display_3	<input type="checkbox"/>	T: 21/ CH:10 Display_3	Target	Analogue	AO_3
1 (IO-Module) EY6IO71 (23/24)	Display_4	<input type="checkbox"/>	T: 23/ CH:11 Display_4	Target	Analogue	AO_4
1 (IO-Module) EY6IO71 (25/26)	Display_5	<input type="checkbox"/>	T: 25/ CH:12 Display_5	Target	Analogue	AO_5
1 (IO-Module) EY6IO71 (27/28)	Display_6	<input type="checkbox"/>	T: 27/ CH:13 Display_6	Target	Analogue	AO_6
1 (IO-Module) EY6IO71 (29/30)	Display_7	<input type="checkbox"/>	T: 29/ CH:14 Display_7	Target	Analogue	AO_7
1 (IO-Module) EY6IO71 (31/32)	Display_8	<input type="checkbox"/>	T: 31/ CH:15 Display_8	Target	Analogue	AO_8
2 (IO-Module) EY6IO50 (1/2)	LED_Relay_1	<input type="checkbox"/>	T: 1/2 CH:0 LED_Relay_1	Target	Binary	BO_1
2 (IO-Module) EY6IO50 (3/4)	LED_Relay_2	<input type="checkbox"/>	T: 3/4 CH:1 LED_Relay_2	Target	Binary	BO_2
2 (IO-Module) EY6IO50 (5/6)	LED_Relay_3	<input type="checkbox"/>	T: 5/6 CH:2 LED_Relay_3	Target	Binary	BO_3
2 (IO-Module) EY6IO50 (7/8)	LED_Relay_4	<input type="checkbox"/>	T: 7/8 CH:3 LED_Relay_4	Target	Binary	BO_4
2 (IO-Module) EY6IO50 (9/10)	LED_Relay_5	<input type="checkbox"/>	T: 9/1 CH:4 LED_Relay_5	Target	Binary	BO_5

Figure 9 Table display of the configured labels

7.6.3 Time setting for the dimming of the backlight

This setting is made globally for all modules of one station. The "Parameter for local operating unit" are located on the shaft side of a modulo 6 station. The "Edit" button opens a dialogue with two settings:

- Backlight timeout
Time in seconds without user action to dim down the backlight (eco mode, 15% of max. brightness)
Default: 0 (eco mode OFF)
- Brightness of the backlight.
Value in % of brightness on operation. (Recommended > 20%)
Default: 100 (brightest)

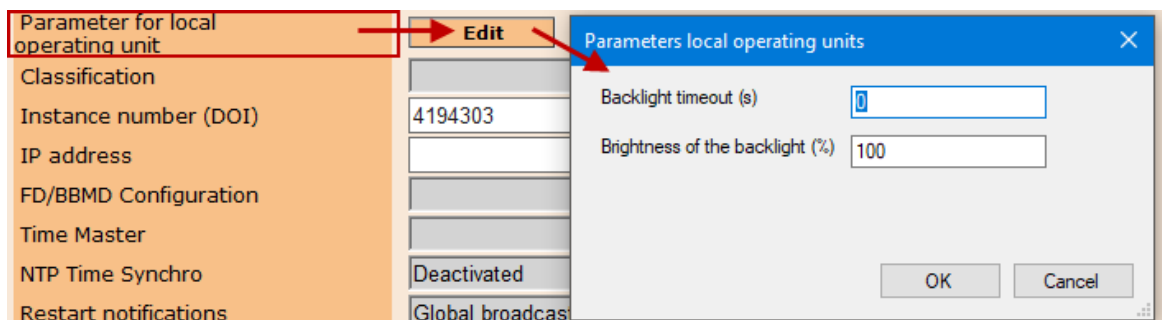



Figure 10 Settings for local operation units

7.6.4 Setting the "Secure Value" value

The value "Secure Value" is shown on the **modu600-LO** with the symbol . This value is configured with CASE Engine and for output signals only.

You can select the modulo 6 station, double-click and the map appears. Then select the output signal on the right piano.

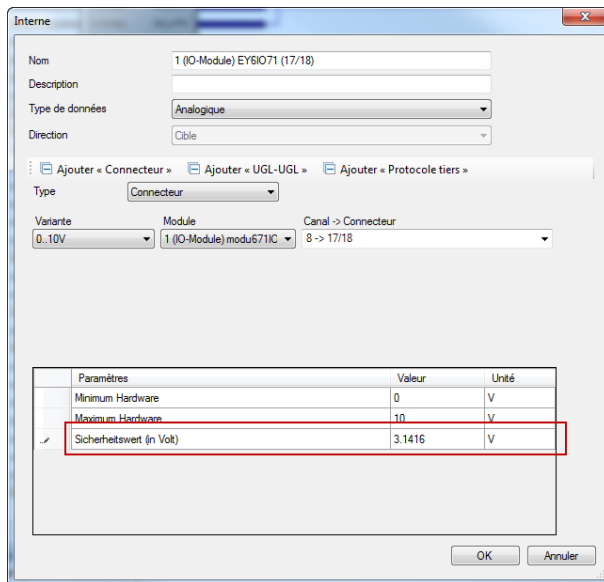

Figure 11 Configuration dialogue for an analog output signal

You can also select the "Configuration of signals and modules" option from the context menu.

Functionality and operation

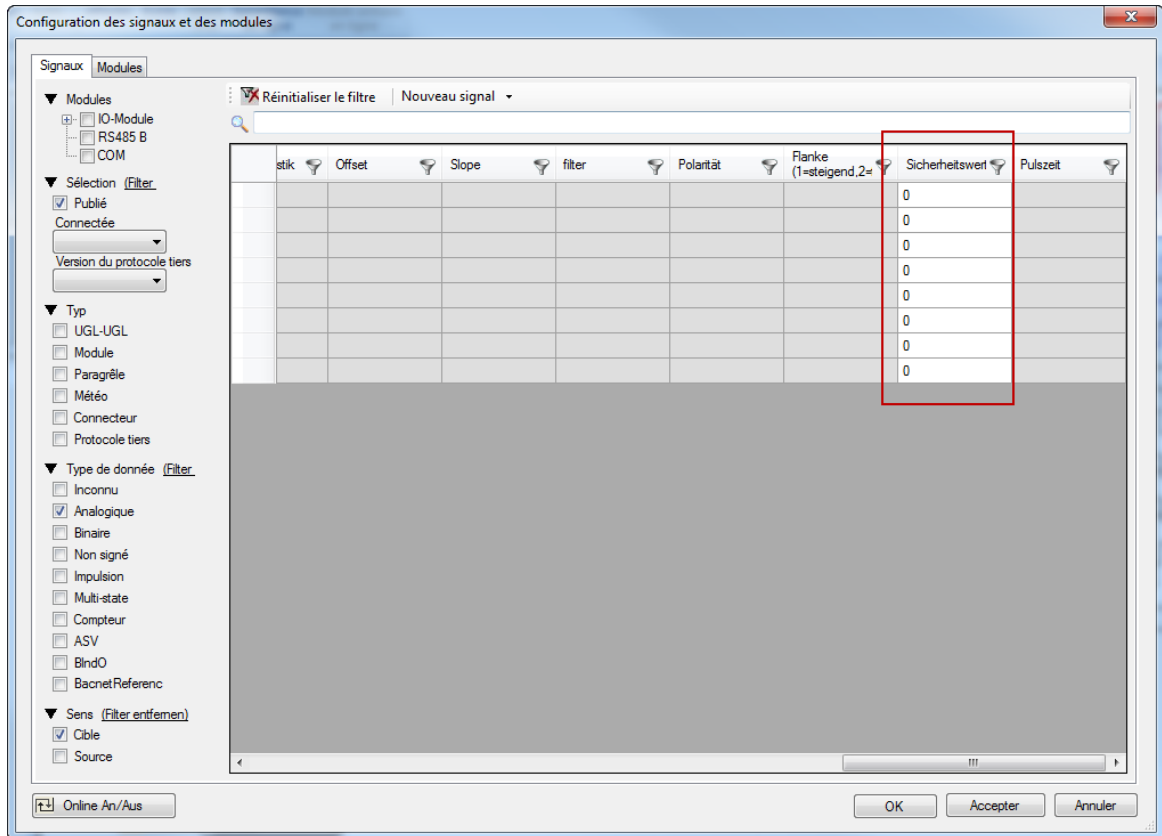

Figure 12 Module and signal configuration table.

When restarting the Station after it has been shut down, the overridden signals are maintained as long as the **modu600-LO** remains plugged in.

8 Maintenance

modu600-LO does not require any maintenance. However, the following is recommended:

- The module does not have a protective screen. Do not touch the screen, either with your fingers or with sharp objects
- If necessary, clean the screen with a dry, clean microfibre cloth with due care
- Note that the module is not protected against electrostatic discharges. Do not touch the spring contacts on the back!
- The module is hot-pluggable and can be used universally on the modulo 6 I/O modules
- The module is not designed for continuous exchanging between I/O modules

FAQ

9 FAQ

9.1 What happens when LOI and WS/app are used simultaneously?

New operating mode as of FW. 1.2.3

Rules:

- Manual override over LOI or App is regulated according to the "last-win" principle.
- The modulo 6 app can reset an override of LOI, and vice versa
- Manual override over LOI or app is persisted in the I/O module
- If LOI is removed or Bluetooth communication is interrupted, overrides are maintained by the I/O-modules
- Overrides are not lost in case of power failure
- Only authorised users can perform overrides via the modulo 6 App (login)
- Secure Value applies when no override has been set and the AS is not present

The behaviour when LOI and modulo 6 App are used simultaneously concerning overriding output signals is governed by the "last wins" principle. This means that a signal override from one can be reset by the other (Reset, Auto) or overridden with another value. There is no priority of one over the other.

The override values are stored on the IO module so that it is only possible to effectively reset them if they are explicitly reset via LOI or App. In case of loss of app access data and in the absence of LOI, the only remaining option is to reset the station and download the project.

9.2 What does this icon mean?

This icon indicates that the communication between **modu600-LO** and the I/O module is not working even though the I/O module is supplying power to **modu600-LO**



Make sure that the module is installed correctly, that the spring contacts are clean and undamaged, and that the contact areas of the I/O module are clean and free.

9.3 Which icon is displayed, and when?

The following table illustrates the conditions under which the different symbols are displayed. When multiple states coexist simultaneously, the following prioritisation generally applies:

1. Alarm/Fault
2. Override
3. Out of Service

For example, the alarm state of the BACnet object is displayed even though the object has been set to Out of Service, or has been overridden via LOI, and the output is in a valid area.

Thus, the behaviour is identical to that of moduWeb Unity and SAUTER Vision Center.

State	Status flags					Ack'ed Transitions			Symbol	StateNumber	Tooltip text
	Offline	InAlarm	Fault	Overridden	Out of Service	ToOffNormal	ToFault	ToNormal			
Data Retrieval	-	-	-	-	-	-	-	-			Retrieving data
Offline		-	-	-	-	-	-	-		1	Offline
Alarm-Offnormal Not-Acked				-	-		-	-		2	In Offnormal Alarm (acknowledge required)
Alarm-Offnormal All-Acked				-	-					3	In Offnormal Alarm (all acknowledged)
Alarm-Offnormal Others-Not-Acked				-	-					4	In Offnormal Alarm (other acknowledge required)
Alarm-Fault Not-Acked				-	-	-		-		5	In Fault Alarm (acknowledge required)
Alarm-Fault All-Acked				-	-					6	In Fault Alarm (all acknowledged)
Alarm-Fault Others-Not-Acked				-	-					7	In Fault Alarm (other acknowledge required)
Fault				-	-	-	-	-		7b	Fault
Overridden					-					9	Overridden
OutOfService						-	-	-		8	Out of Service
Normal Any-Not-Acked										10	Normal (at least one acknowledge required)
Normal All-Acked										11	Normal

- true
- false
- At least one of acked-transitions is False

Table 4 Truth table for displaying the icons

9.4 How can I change the language of the GUI?

modu600-LO does not support localisation. However, no fixed programmed texts have been used, with the single exception being in the info view.

modu600-LO supports UTF-8. The labels for the signals are displayed according to the project, in Roman, Cyrillic or Greek characters (e.g. no Hebrew, Arabic or Asian characters). All of the supported characters are shown in the Annex.

9.5 How can I update the firmware of the LOI?

The station automatically updates the firmware to the correct version so that it is an optimal match for the I/O module. The update is only carried out when the station is restarted and only when the station is ready for operation again. During the update, the LED flashes orange and the screen is black.

If the station is not configured and no program is running on it, the LOIs are updated in parallel.

FAQ

Updating the firmware takes

- ~2.5 minutes if up to 10 LOI modules are connected
- ~5 minutes if up to 20 LOI modules are connected
- ~10 minutes if 20 or more LOI modules are connected

9.6 What happens with polarity = reverse?

With the signal configuration of digital outputs, it is possible to invert the polarity of the signal. This setting is fixed in modulo 6 and cannot be made during the operation, but with a program download.

BO	Relay		Open Collector	
	Direct	Reverse	Direct	Reverse
0	Open, not conducting	Closed, conducting	Closed ⁶ , non-conducting	Open, conducting
1	Closed, conducting	Open, non-conducting	Open ⁷ , conducting	Closed, non-conducting

Table 5 PV and polarity of digital outputs

This inversion is controlled by the I/O module and is not visible on the **modu600-LO**. The display of the binary switch is not inverted.

⁶ With a pull-up resistor as load, $V_{out}=V_{dc}$

⁷ With a pull-up resistor as load, $V_{out}=0$

FAQ

9.7 Behaviour of backlight

The backlight has 2 brightness levels. The darker level has been defined as 15% of the maximum brightness. The brighter level can be configured as a % of the maximum brightness in CASE Engine (see 7.6.3). It makes no sense to configure the brightness lower than 15%.

The backlight is normally in eco-mode, i.e. the predefined darker level. When one of the LOIs is operated, all of them are switched to the brighter level, provided no LOI was in bright mode. After the set time (see 7.6.3), all unused LOIs are switched back to eco-mode, except for the LOI that is in use.

Phase	LOI 1	LOI 2	LOI 3	LOI 4	...	LOI n
<i>0</i>	Eco	Eco	Eco	Eco	Eco	Eco
<i>1</i>		Operation				
<i>2</i>	Bright	Bright	Bright	Bright	Bright	Bright
<i>3</i>		Operation				
<i>4</i>	Eco	Bright	Eco	Eco	Eco	eco

Table 6 **Phase 0: all LOIs are in eco mode.**
Phase 1. LOI 2 is operated.
Phase 2. All LOI switch to bright.
Phase 3. LOI 2 is operated further.
Phase 4. After the timeout, the unused LOI switch back to eco.

Figures

Figures

Figure 1	Schema of the different views in modu600-LO and the navigation between the views.....	18
Figure 2	Areas in the overview	23
Figure 3	Areas in the list view.....	27
Figure 4	Areas in the detailed view	29
Figure 5	Context menu of a modulo 6 station and path to the LOI label editor.....	41
Figure 6	Editor table for general configuration	41
Figure 7	Tab for individual configuration, which is activated via the checkbox	42
Figure 8	Selection from the "Field" column.....	42
Figure 9	Table display of the configured labels.....	43
Figure 10	Settings for local operation units	43
Figure 11	Configuration dialogue for an analog output signal.....	44
Figure 12	Module and signal configuration table.....	45

10 Tables

Table 1	Summary of the signal components and the central text field based on signal type and BACnet object	26
Table 2	Configuration options based on channel type	30
Table 3	Nominal and effective ranges of the analogue signals.....	35
Table 4	Truth table for displaying the icons.....	48
Table 5	PV and polarity of digital outputs.....	50
Table 6	Phase 0: all LOIs are in eco mode. Phase 1. LOI 2 is operated. Phase 2. All LOI switch to bright. Phase 3. LOI 2 is operated further. Phase 4. After the timeout, the unused LOI switch back to eco.	51

Annexe**11 Annexe****11.1 Didact Gothic – Regular Font Copyright**

Copyright (c) 2009, 2010, 2011 Daniel Johnson (il.basso.buffo@gmail.com)

This Font Software is licensed under the SIL Open Font License, Version 1.1.

This license is copied below and is also available with an FAQ at:

<http://scripts.sil.org/OFL>

SIL OPEN FONT LICENSE version 1.1 – 26 February 2007

PREAMBLE

The goals of the Open Font License (OFL) are to stimulate worldwide development of collaborative font projects, to support the font creation efforts of academic and linguistic communities, and to provide a free and open framework in which fonts may be shared and improved in partnership with others.

The OFL allows the licensed fonts to be used, studied, modified and redistributed freely as long as they are not sold by themselves. The fonts, including any derivative works, can be bundled, embedded, redistributed and/or sold with any software provided that any reserved names are not used by derivative works. The fonts and derivatives, however, cannot be released under any other type of license. The requirement for fonts to remain under this license does not apply to any document created using the fonts or their derivatives.

DEFINITIONS

“Font Software” refers to the set of files released by the Copyright Holder(s) under this license and clearly marked as such. This may include source files, build scripts and documentation.

“Reserved Font Name” refers to any names specified as such after the copyright statement(s).

“Original Version” refers to the collection of Font Software components as distributed by the Copyright Holder(s).

“Modified Version” refers to any derivative made by adding to, deleting, or substituting – in part or in whole – any of the components of the Original Version, by changing formats or by porting the Font Software to a new environment.

“Author” refers to any designer, engineer, programmer, technical writer or other person who contributed to the Font Software.

PERMISSION & CONDITIONS

Permission is hereby granted, free of charge, to any person obtaining a copy of the Font Software, to use, study, copy, merge, embed, modify, redistribute, and sell modified and unmodified copies of the Font Software, subject to the following conditions:

- 1) Neither the Font Software nor any of its individual components, in Original or Modified Versions, may be sold by itself.
- 2) Original or Modified Versions of the Font Software may be bundled, redistributed and/or sold with any software, provided that each copy contains the above copyright notice and this license. These can be included either as stand-alone text files, human-readable headers or in the appropriate machine-readable metadata fields within text or binary files as long as those fields can be easily viewed by the user.
- 3) No Modified Version of the Font Software may use the Reserved Font Name(s) unless explicit written permission is granted by the corresponding Copyright Holder. This restriction only applies to the primary font name as presented to the users.
- 4) The name(s) of the Copyright Holder(s) or the Author(s) of the Font Software shall not be used to promote, endorse or advertise any Modified Version, except to acknowledge the contribution(s) of the Copyright Holder(s) and the Author(s) or with their explicit written permission.
- 5) The Font Software, modified or unmodified, in part or in whole, must be distributed entirely under this license, and must not be distributed under any other license. The requirement for fonts to remain under this license does not apply to any document created using the Font Software.

TERMINATION

This license becomes null and void if any of the above conditions are not met.

DISCLAIMER

Annexe

THE FONT SOFTWARE IS PROVIDED “AS IS”, WITHOUT WARRANTY OF ANY KIND, EXPRESS OR IMPLIED, INCLUDING BUT NOT LIMITED TO ANY WARRANTIES OF MERCHANTABILITY, FITNESS FOR A PARTICULAR PURPOSE AND NONINFRINGEMENT OF COPYRIGHT, PATENT, TRADEMARK, OR OTHER RIGHT. IN NO EVENT SHALL THE COPYRIGHT HOLDER BE LIABLE FOR ANY CLAIM, DAMAGES OR OTHER LIABILITY, INCLUDING ANY GENERAL, SPECIAL, INDIRECT, INCIDENTAL, OR CONSEQUENTIAL DAMAGES, WHETHER IN AN ACTION OF CONTRACT, TORT OR OTHERWISE, ARISING FROM, OUT OF THE USE OR INABILITY TO USE THE FONT SOFTWARE OR FROM OTHER DEALINGS IN THE FONT SOFTWARE.

Annexe

"4

fif

© Fr. Sauter AG
Im Surinam 55
CH-4058 Basel
Tel. +41 61 - 695 55 55
Fax +41 61 - 695 55 10
www.sauter-controls.com
info@sauter-controls.com
25.08.2023

Subject to change without
notice

Printed in Switzerland