

AVM 321S, 322S: Valve actuator

How energy efficiency is improved

Automatic adaptation to valve, optimal operator convenience, precision activation and high energy efficiency with minimal operating noise

Features

- In ventilation and air conditioning units for actuating 2- and 3-way valves of type series AVM 321S: VUD, VUE, VUN, BUD, BUE, BUN and AVM 322S: V6R, VQD, VQE, VUG, VUP, VUS, B6R, BQD, BQE, BUG, BUS
- For controllers with constant output (0...10 V / 4...20 mA) or switching output (2-point or 3-point control)
- BLDC motor (brushless DC) with SUT (SAUTER Universal Technology) electronic control unit of the third generation and electronic load-dependent cut-off
- Automatic detection of applied control signal (continuous or switching), operating indicator using bi-colour LED
- Automatic adaptation to the stroke of the valve, between 8 and 20 mm
- Low operating noise
- With the built-in absolute distance measurement system, the position is always maintained in the case of power failure
- The direction of operation, characteristic (linear/equal percentage), running time and control signal (voltage/current) can be adjusted via coding switches
- Integrated forced operation can be set via coding switches (with selectable direction of operation)
- Easy re-initialisation using a coding switch
- Crank handle for external manual adjustment with motor cut-off
- Simple assembly with valve; spindle is automatically connected after control voltage is applied
- Numerous adapters enable the unit to be fitted onto non-SAUTER valves
- Electrical parallel operation of five actuators
- Parameterisation option via the BUS interface
- Three-piece housing made of flame-retardant yellow/black plastic and seals with type of protection IP54
- Maintenance-free gearbox made of plastic; threaded spindle and gearbox base-plates made of steel
- Patented actuator-valve coupling
- Mounting column made of aluminium
- Fixing bracket made of cast light alloy for valve fitting with 20 mm stroke and made of plastic for valve fitting with 8 mm stroke
- Electrical connections (max. 1.5 mm²) with screw terminals
- Two break-out cable inlets for metric cable glands made of plastic M20 × 1.5
- Fitting vertically upright to horizontal, not suspended
- Nominal actuating power 1000 N



AVM32*SF132



Technical data

Power supply

| | |
|---------------------------------|--|
| Power supply 24 V~ | ±20%, 50...60 Hz |
| Power supply 24 V= | -10...20% |
| Power supply 230 V~ | ±15% |
| Power consumption ¹⁾ | < 1.7 W, < 3.5 VA (at nominal voltage, with movement) |

Parameters

| | |
|-------------------------------|------------------------------|
| Nominal force ²⁾ | 1000 N |
| Operating noise ³⁾ | < 30 dB (A) at nominal force |
| Response time | > 200 ms |

¹⁾ For power consumption in combination with accessory 0500570001, see section "Power consumption at nominal voltage"

²⁾ Actuating power 1000 N under nominal conditions (24 V, 25 °C ambient temperature, 50 Hz). With boundary conditions (19.2 V~ / 28.8 V~ / 21.6 V= / 28.8 V=, -10 °C / 55 °C, 60 Hz) and running time, the actuating/tensile force is minimised to 800 N

³⁾ Noise level with the slowest running time, measuring distance 1m



| | |
|---|--|
| Temperature of medium ⁴⁾ | 0...100 °C |
| Nominal voltage | 24 V~/= |
| Characteristic | Linear/equal percentage |
| Control signal y ⁵⁾ | 0...10 V, R _i ≥ 50 kΩ 4...20 mA, R _i ≤ 50 Ω |
| Positional feedback signal y ₀ | 0...10 V, load ≥ 5 kΩ |
| Starting point U ₀ | 0 or 10 V |
| Starting point I ₀ | 4 or 20 mA |
| Control span ΔU | 10 V |
| Control span ΔI | 16 mA |
| Hysteresis X _{sh} | 160 mV 0.22 mA |

Ambient conditions

| | |
|-----------------------------------|-------------|
| Operating temperature | -10...55 °C |
| Storage and transport temperature | -40...80 °C |
| Humidity without condensation | 5...85% rh |

Standards and directives

| | | |
|----------------------------|--|---|
| | Type of protection | IP54 (EN 60529) |
| | Protection class | III (EN 60730-1), EN 60730-2-14 |
| CE conformity according to | EMC Directive 2014/30/EU | EN 610000-6-1, EN 610000-6-2, EN 610000-6-3, EN 610000-6-4 |
| | Low-Voltage Directive 2014/35/EU | EN 60730-1, EN 60730-2-14 (AVM32*F110 and F120) |
| | Over-voltage categories | III |
| | Degree of contamination | II |
| | Max. altitude | 2000 m |
| | Machinery Directive 2006/42/EC (according to Appendix II, 1B) | EN ISO 12100 |

Overview of types

| Type | Nominal voltage | Nominal stroke | Running time [s/mm] | Dimensions W x H x D | Weight |
|-------------|-----------------|----------------|---------------------|----------------------|--------|
| AVM321SF132 | 24 V~/= | 8 mm | 12 (4) | 160 × 187 × 88 mm | 1.5 kg |
| AVM322SF132 | 24 V~/= | 20 mm | 6 (4) | 160 × 241 × 88 mm | 1.6 kg |

 CSA-certified actuators on request (only for devices with supply voltage 24 V~/=). Accessory is not CSA-certified.

Accessories

AVM 321S, 322S

| Type | Description |
|------------|---|
| 0500570003 | Constant 230 V module |
| 0500420001 | Split-range unit module |
| 0500420002 | 4...20 mA feedback module |
| 0500570001 | Energy module for reset function |
| 0510600001 | Cable module, 1.2 m, 3-wire, PVC |
| 0510600002 | Cable module, 1.2 m, 3-wire, halogen-free |
| 0510600003 | Cable module, 1.2 m, 6-wire, PVC |
| 0510600004 | Cable module, 1.2 m, 6-wire, halogen-free |
| 0510600005 | Cable module, 5 m, 3-wire, PVC |
| 0510600006 | Cable module, 5 m, 3-wire, halogen-free |
| 0510600007 | Cable module, 5 m, 6-wire, PVC |
| 0510600008 | Cable module, 5 m, 6-wire, halogen-free |

⁴⁾ At media temperature > 100 °C appropriate accessory must be used (temperature adapter); at media temperature < 0 °C appropriate accessory must be used (stuffing box heater)

⁵⁾ Positional feedback signal: also for 2- or 3-point, depending on type of connection

AVM 321S

| Type | Description |
|------------|---|
| 0372249001 | Adapter required when temperature of the medium is 100...130 °C (recommended for temperatures < 10 °C) DN 15...50 |
| 0372249002 | Adaptor required when temperature of the medium is 130...150 °C, DN 15...50 |
| 0510480003 | Dual auxiliary switch for 8 mm stroke |

AVM 322S

| Type | Description |
|------------|--|
| 0500240001 | Temperature adaptor for media temperature > 100...180 °C |
| 0500240002 | Temperature adaptor for media temperature > 130...240 °C |
| 0510240012 | Mounting set V6... / B6... up to 20 mm stroke |
| 0510390006 | Adapter set for non-SAUTER valves (Siemens) with stroke up to 20 mm and spindle diameter of 10 mm |
| 0510390007 | Adapter set for non-SAUTER valves (JCI): VBD-4xx4 DN 15...40, VBD-4xx8 DN 15...40, VBF-2xx4, VBF2xx8, VBB-2xxx, VG82xx VG84xx, VG88xx VG89xx |
| 0510390008 | Adapter set for non-SAUTER valves (Honeywell): V5025A DN 15...80, V5049A or B DN 15...65, V5050A DN 15...80, V5095A DN 15...80, V5328A DN 15...80, V5329A DN 15...80 |
| 0510390009 | Adapter set for non-SAUTER valves (LDM): RV113 R/M, DN15-80 |
| 0510390010 | Adapter set for ITT-Dräger: PSVF DN 15...32, PSVD DN 15...32, SVF DN 15...32, SVD DN 15...32 |
| 0510390012 | Adapter set for non-SAUTER valves (Belimo): H6..R DN 15...65, H7..R DN 15...65, H4..R DN 15...50, H5..B DN 15...50, H6..N DN 15...65, H7..N DN 15...65 |
| 0510390028 | Adapter set for non-SAUTER valves (Frese), stroke 20 mm |
| 0510480004 | Dual auxiliary switch for 20 mm stroke |

💡 Accessory is not CSA-certified.

💡 The CASE Components configuration tool can be downloaded from the CASE Suite product page (GZS 100, 150) on the SAUTER homepage.

Description of operation

This actuator is used to operate 2- and 3-way valves in ventilation and air conditioning units and must only be used for these purposes. Use outside of HVAC installations is only permitted after consultation with the manufacturer.

Depending on the type of connection (see connection diagram), the actuator can be used as a continuous (0...10 V or 4...20 mA), 2-point (OPEN/CLOSE) or a 3-point actuator (OPEN/STOP/CLOSE).

The running time of the actuator can be set with switch S1 according to the respective requirements.

Switch S2 can be used to change the direction of operation.

In the end positions (valve limit stop or when the maximum stroke is reached) or upon overload, the electronic motor cut-off (no limit switch) responds and turns off the motor.

The external crank handle enables manual positional setting. After the crank handle is folded back, the actuator moves to the target position again (without initialisation). When the crank handle is folded out, the actuator remains in this position.

Intended use

This product is only suitable for the purpose intended by the manufacturer, as described in the "Description of operation" section.

All related product regulations must also be adhered to. Changing or converting the product is not admissible.

Engineering and fitting notes

The concept of brushless DC motor/electronics ensures electrical parallel operation of up to five actuators of the same type.

The valve is mounted directly on the actuator and fixed with screws (no further adjustments are required). The actuator is connected with the valve spindle automatically. As delivered ex works, the actuator spindle is in the middle position.

Condensate, dripping water, etc. must be prevented from entering the actuator along the valve spindle.

There are two break-out cable inlets in the housing for two metric plastic cable glands M20 × 1.5 which automatically break out when a cable inlet is screwed in.

If the cable resistance is > 1.5 Ω, it is recommended to separate the ground from the supply and the signal.

The cross-section of the power cable must be selected based on the cable length and the number of actuators. With five parallel actuators and a cable length of 50 m, a cable cross-section of 1.5 mm² and a line resistance of > 1.5 Ω must be used (power consumption of the actuator × 5). According to building installation regulations, the lines must be protected from overload or short circuit.



Note for UL-CSA applications:

The installed lines and cross-sections which are to be connected by the customer must comply with the requirements of NFPA70 (NEC) in the USA, and in Canada with the requirements of the standard C22.1-12 (CE Code).

The coding switches and the SLC interface for CASE Drives are accessible via a prepared opening in the connection area of the actuator. Conversion and operation is possible while the actuator is energised.



CAUTION!

Always disconnect the device from the mains before removing the plastic cover of the connection area. The housing must not be opened.

Specific standards such as IEC/EN 61508, IEC/EN 61511, EN ISO13849 and the like have not been taken into account.

Local requirements regarding installation, usage, access, access rights, accident prevention, safety, dismantling and disposal must be taken into account.

Place of installation

The devices may only be used indoors.

It is not admissible to use them in the following locations:

- in outdoor areas
- in potentially explosive atmospheres
- on ships or in vehicles
- in plants or machines with required functional safety.

Additional information

| | |
|--|------------|
| Fitting instructions | P100011900 |
| Declaration on materials and the environment | MD 51.375 |
| Declaration of incorporation | P100012470 |

Power consumption at nominal voltage

| Type | Running time (s/mm) | Status | Active power P (W) | Apparent power S (VA) |
|--|---------------------|------------|--------------------|-----------------------|
| AVM321S | 12 / (4) | Operation | < 1.7 | < 3.5 |
| | | Standstill | < 0.45 | – |
| | | Sizing | – | ≥ 4.5 |
| AVM322S | 6 / (4) | Operation | < 1.7 | < 3.5 |
| | | Standstill | < 0.45 | – |
| | | Sizing | – | ≥ 4.5 |
| Max. power consumption with accessory 0500570001 for all types | | 24 V= | 5.2 | – |
| | | 24 V~ | 6.2 | 11 |

Connection as 2-point valve actuator (24 V)

The OPEN/CLOSE activation is via two wires.

The actuator is connected to a permanent voltage via terminal MM and terminal 01.

When voltage (24 V) is applied to terminal 02, the actuator spindle extends into the end position.

After the voltage is switched off at terminal 02, the actuator automatically retracts into the base position.

Terminal 03 must not be connected or touch other contacts. We recommend that you insulate these.

Connection as 3-point valve actuator (24 V)

If voltage is applied to terminals MM and 01 (or 02), the valve can be moved to any position.

If voltage is applied to terminals MM and 01, the actuator spindle retracts.

If the electrical circuit is closed on terminal MM and 02, the actuator spindle extends.

If there is no voltage on terminals 01 and 02, the actuator remains in the respective position until voltage is applied again.

Terminal 03 must not be connected or touch other contacts. We recommend that you insulate these.

Connection to a control voltage (0...10 V or 4...20 mA)

The built-in positioner controls the actuator depending on controller's output signal y . A voltage signal (0...10 V) at terminal 03 serves as the control signal. Coding switch S4 can be used to switch to a current input (4...20 mA). If there is voltage on terminals MM/01 and a rising positioning signal, the actuator spindle extends. The direction of operation can be reversed with coding switch S2.

The starting point and control span are fixed. For setting partial ranges (only for voltage input), a split-range unit is available as an accessory (see split-range unit function).

After the connection of the power supply and the initialisation, the actuator moves to every valve stroke between 0% and 100%, depending on the control signal. Thanks to the electronics and the absolute distance measurement system, no stroke is lost, and the actuator does not require periodic re-initialisation.

If the control signal 0...10 V is interrupted in the direction of operation 1, the actuator spindle retracts completely.

If the control signal 0...10 V is interrupted in the direction of operation 2, the actuator spindle extends completely.

With coding switch S3, the characteristic of the valve/actuator combination can be adjusted. An equal-percentage characteristic can only be generated when the actuator is used as a continuous actuator.

Initialisation and feedback signal

The actuator initialises itself automatically when it is connected as a continuous actuator (not in 2-/3-point mode). With the first application of voltage the actuator moves until it reaches the mechanical stop and connects to the valve.

For 8 mm travel range of AVM321SF132

After the actuator has stopped moving to connect to the valve, it moves to the upper first stop and then to the 8 mm travel range in the opposite direction. If the valve travel range is greater than 8 mm, the initialisation stops after 8 mm. The two values are recorded and stored by the absolute distance measurement system. The control signal and the feedback are adapted to this effective stroke. If it cannot move the 8 mm travel range, the initialisation is cancelled and the actuator indicates "Under-range". After initialisation, the actuator goes to every valve stroke between 0% and 100%, depending on the control voltage.

For 20 mm travel range of AVM322SF132

After the actuator has stopped moving to connect to the valve, it moves to the upper and lower stop. The travel range thus achieved is recorded by the measurement system and apportioned as 0 to 100% travel range. The control signal and the feedback are adapted to this effective stroke.

In case of a power failure or the removal of the power supply, no re-initialisation needs to be carried out. The values remain saved.

If the initialisation is interrupted, the initialisation restarts when the voltage is reapplied.

You trigger a re-initialisation by moving coding switch S8 from OFF to ON or vice versa.

When the process is triggered, the LED flashes green.

During initialisation, the feedback signal is inactive or equal to the value "0". The initialisation is carried out with the shortest running time. The re-initialisation is only valid when the whole process is complete.

If a stroke change is carried out, a re-initialisation must be triggered so that the new stroke can be adapted.

If the valve actuator detects jamming, it will report this by setting the feedback signal to 0 V after about 90 s. During this time, the actuator continues to try to overcome the jamming. If the jamming can be overcome, the normal control function is activated again and the feedback signal is restored.

With 2-point or 3-point control without a feedback signal, no initialisation is performed.

Continuous control can also be implemented with a 230 V power supply with the external accessory 0500570003 "230 V module". You must ensure that the neutral wire of the controller is connected to the control voltage. The neutral wire of the power supply may only be used for the 230 V module.

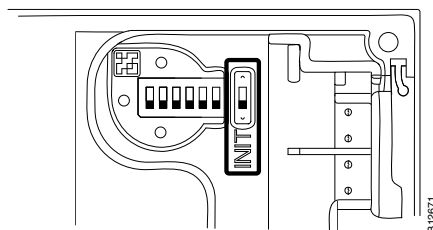

Forced operation

Forced operation is activated via coding switch S5. To use this function, an external 2-point controller must be attached to terminal 6. The 2-point controller functions as a normally-closed contact.

If the 2-point controller opens the electrical circuit, the actuator spindle moves to the end position defined by coding switch S6.

2-/3-point operation using the reset signal

If terminal 6 is continuously connected to the power and coding switch S5 is set to OFF, reset signal 0...10 V can be used.

When this function is used, the actuator automatically performs an initialisation during commissioning.

Split-range module, accessory 0500420001

Starting point U_0 and control span U can be set with the potentiometer. In this way, several control units can be operated in sequence or cascade by the control signal of the controller. The input signal (partial range) is amplified into an output signal of 0...10 V.

CASE Drives PC tool, accessory 0510220001

CASE Drives allows you to set and read the actuator parameters on site. The connection is via a serial port on the PC (laptop) and a socket on the actuator. The set consists of: The software including installation and operating instructions, fitting instructions, connection plug, cable (1.2 m long) and interface converter for the PC. The application is designed for commissioning and service engineers as well as experienced operators.

Feedback signal converter, accessory 0500420002

With the feedback signal converter accessory 0500420002, the output signal y_o is converted from a voltage signal 0...10 V into a current signal 4...20 mA.

Energy module with super caps for reset function, accessory 0500570001

The energy module enables automatic movement to an adjustable end position in the event of a power supply failure. This is performed by the stored energy in the super caps. The super caps are continuously charged during normal operation via the connected power supply by means of a fitness function. This function ensures that the super caps are always charged with the necessary capacity during their stand-by time. The desired end position after a reset process can be set using a DIP switch (see MV 0510240012).

There are two different cases for the running time of the actuator during the reset process:

- DIP switch 5 "Terminal 06 active" is ON: The actuator is operated with the fastest possible running time.
- DIP switch 5 "Terminal 06 active" is OFF: The actuator is operated with the currently set running time.

The reset function is triggered when the system detects a voltage $< 13.2 \text{ V} =$ or $< 12 \text{ V} \sim$. The system switches back to normal operation at $> 16.7 \text{ V} =$ or $> 15 \text{ V} \sim$.

All functions of the SUT actuator are still available when using the energy module. An LED on the energy module indicates the current operating status of the actuator.

Energy module LED

| LED | Description |
|-------------------|---|
| Flashes green | Charging process active |
| Lights up green | Actuator in normal operation |
| Flashes red-green | Charging process and reset process active |
| Off | System is off and super caps empty |
| Lights up red | System has detected and triggered reset function. Reset function active |
| Flashes red (T2s) | Life expectancy of super caps reached. Module must be replaced |

**Note**

The use of the energy module (accessory 0500570001) in combination with 4-20 mA activation is possible for AVM32*SF132 actuators with manufacturing date from E1827 onwards.

The current consumption of the energy module for its charging processes (up to 0.6 A) must be considered. The conductor cross-sections must be dimensioned accordingly.

- The voltage drop in the MM conductor must be considered and, if necessary, the wiring of the positioning and feedback signals must be optimised.
- Accessory 0500570001 changes the mode of operation of the actuator from 1AB to 1AA (EN 60730).
- Accessory 0500570001 cannot be used for safety and TÜV applications.
- Unsuitable for plants of categories 1 to 4 according to Directive 2014/68/EU for pressure equipment.
- After commissioning, the system is charged before normal operation is activated. This can take up to four minutes, depending on the state of charge of the super caps.

Valve actuator LED

| LED | Description |
|---------------------|--|
| Flashes green (T1s) | Valve adapting, initialisation |
| Flashes green (T3s) | Position reached |
| Lights up green | Actuator spindle moves IN/OUT |
| Flashes orange | Manual adjustment activated |
| Flashes red | Actuator jammed, actuator at end stop |
| Lights up red | Incorrect configuration of forced operation, undervoltage, insufficiently adapted stroke |

Disposal

When disposing of the product, observe the currently applicable local laws.

More information on materials can be found in the Declaration on materials and the environment for this product.

Coding switch

| de Schalterstellung fr Position du commutateur en Switch position it Posizione dell'interruttore es Posición del interruptor sv Brytarläge nl Schakelaarstand | de Stelzeit fr Temps de positionnement en positioning time it tempo di manovra es tiempo de ajuste sv ställtid nl steltijd | de Wirksinn fr Sens d'action en Direction of operation it Direzione dell'azione es Sentido de mando sv Driftriktning nl Werkingsrichting | de Kennlinie Antrieb* fr Courb caractéristique du servomoteur en Actuator characteristic it Curva caratteristica attuatore es Curva característica del motor sv Kurva, drivning nl Karakteristiek aandrijving | de Stellsignal* fr Signal de positionnement en Positioning signal it Segnale di regolazione es Señal de mando sv Styrsignal nl Stuursignaal | de Zwangssteuerung* fr Commande forcée en Forced operation it Comando forzato es Mando desmodrómico sv Tvångsstyrd ventil nl Dwangbesturing | de Schliesspunkt Zwangssteuerung* fr Point de fermeture de la commande forcée en Closing point for forced operation it Comando forzato punto di bloccaggio es Punto de cierre del mando desmodrómico sv Stängningspunkt, tvångsstyrd ventil nl Sluitpunt dwangbesturing |
|---|--|--|---|---|---|---|
| | AVM321: 12 s/mm AVM322: 6 s/mm | | | DC 0...10 V | prio. off | |
| | AVM321: 4 s/mm AVM322: 4 s/mm | | | | | |
| | | | | | | |
| | | | | | | |
| | | | | 4...20 mA | | |
| | | | | | prio. on | |
| | | | | | | |

de *Gilt nur für stetig Modus
fr *S'applique uniquement au mode de régulation
en *Applies for continuous mode only
it *Vale solo per modo „continuo“
es *Se aplica solo para modo continuo
sv *Gäller endast för kontinuerlig reglering
nl *Geldt uitsluitend voor continuïus modus

Connection diagram

Modulating action

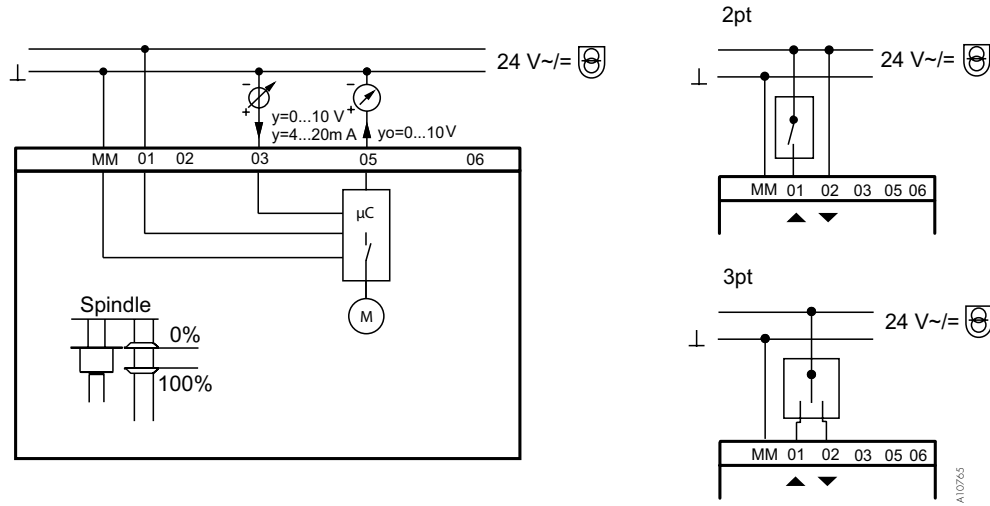

2pt/3pt multi-position action with feedback signal

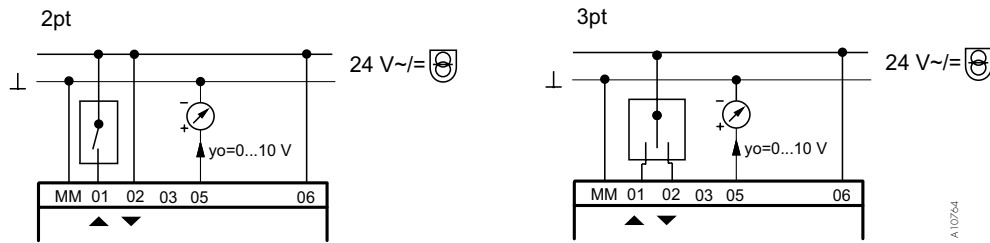

Modulating action with forced operation

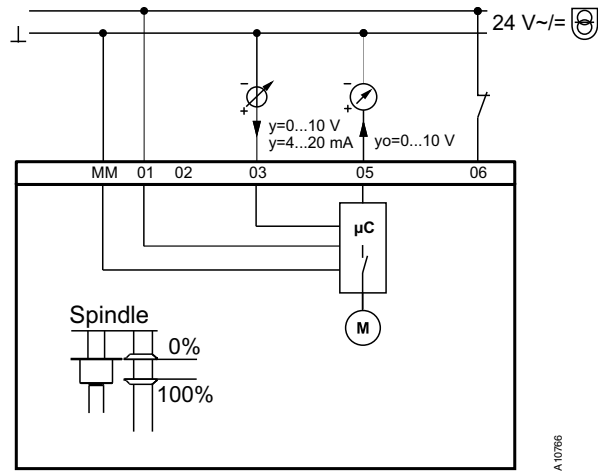

With accessory 0500570001

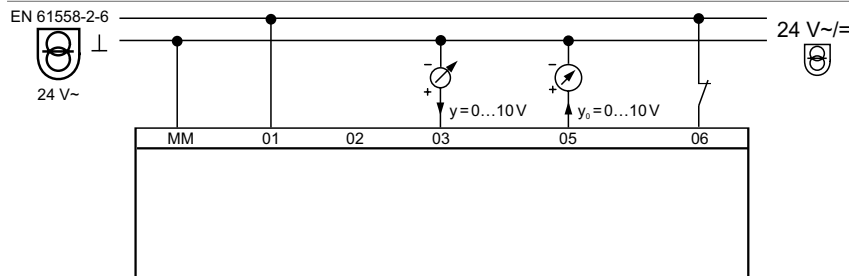

2pt/3pt multi-position action with feedback signal

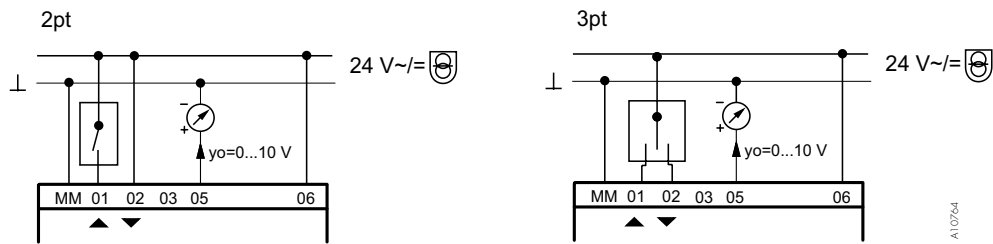

Dimension drawing

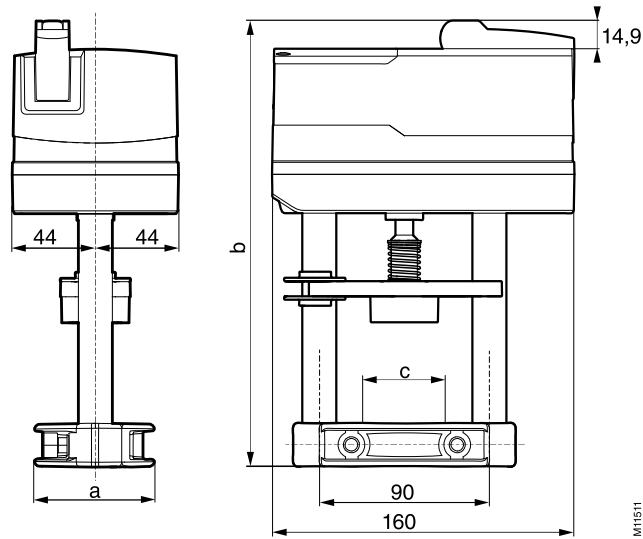

| Type | a | b | c |
|---------|----|-------|----|
| AVM 321 | 53 | 187.4 | 33 |
| AVM 322 | 64 | 241 | 44 |

Accessories

0500420001, 0500420002, 0500420003, 0500570001

