

AKM 105S, 115S: Rotary actuator with SAUTER Universal Technology (SUT) for ball valve

How energy efficiency is improved

Automatic adaptation to ball valve, precise activation and high energy efficiency with minimal operating noise.

Features

- For operating 2- and 3-way ball valves VKR, VKRA, BKR, BKRA, VKAI, VKAA, BKLI, BKTI, BKTA, (AKM115S) and 6-way ball valve B2KL
- For controllers with constant output (0...10 V) or switching output (2-/3-point control)
- Assembly with ball valve without the use of tools
- Stepping motor with SAUTER Universal Technology (SUT) electronic control unit
- Electronic force-dependent motor cut-off
- Automatic recognition of applied control signal (continuous or switched)
- Coding switch for selection of characteristic and running time (35 s, 60 s, 120 s)
- Type of characteristic (linear/quadratic/equal-percentage) can be set on the actuator
- Direction of operation can be selected directly on the cable
- Maintenance-free gear unit
- Gear unit can be disengaged in order to position the ball valve manually (using the lever)
- Bracket and bayonet ring made of glass-fibre-reinforced plastic for fitting onto ball valve

Technical data

Power supply		
Power supply 24 V~		±20%, 50...60 Hz
Power supply 24 V=		-10%...20%
Power consumption		4.9 W/8.7 VA
Parameters		
Running time ¹⁾		35/60/120 s
Angle of rotation		90°
Response time		200 ms
Power cable		1.2 m, 5 × 0.5 mm ²
Positioner		
Positioning signal y		0...10 V, R _i > 100 kΩ
Positional feedback signal		0...10 V; load > 10 kΩ
Starting point U ₀		0 V or 10 V
Control span ΔU		10 V
Switching range X _{sh}		200 mV
Ambient conditions		
Temperature of medium ²⁾		Max. 100 °C
Admissible ambient temperature		-10...55 °C
Admissible ambient humidity		5...95% rh, no condensation
Construction		
Fitting		Vertically upright to horizontal, not upside down
Weight		0.7 kg
Housing		Lower section black, upper section yellow
Housing material		Fire-retardant plastic
Standards and directives		
Type of protection		IP54 as per EN 60529
Protection class		III as per IEC 60730
CE conformity according to		
EMC Directive 2014/30/EU		EN 61000-6-1, EN 61000-6-3 EN 61000-6-4
Directive 2006/95/EC		Machine directive (EN 1050)

¹⁾ For a running time of 35 s, the torque is halved

²⁾ At media temperatures < 5 °C or > 100 °C, appropriate accessory must be used



AKM115SF132

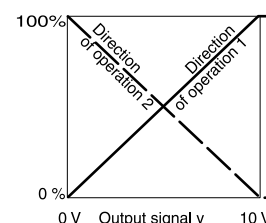

Overview of types

Type	Torque
AKM105SF132	4 Nm
AKM115SF132	8 Nm

Accessories

Type	Description
0313529001	Split-range unit for adjusting sequences, fitted in separate junction box
0372462001	CASE Drives PC tool for configuring the drives by computer
0510420001	Adaptor required when temperature of the medium > 100 °C
0510240011	Adaptor required when temperature of the medium < 5 °C
0510480001	Auxiliary change-over contacts, single
0510480002	Auxiliary change-over contacts, double

 Auxiliary change-over contacts: Infinitely variable 0...100%, admissible load 5(2) A, 24...230 V

Description of operation

Depending on the type of connection (see connection diagram), the actuator can be used as a continuous 0...10 V, 2-point (OPEN/CLOSE) or 3-point actuator with an intermediate position (OPEN/STOP/CLOSE).

The running time of the actuator can be set with the coding switch according to requirements. The coding switch can be used to select the equal-percentage, linear or quadratic characteristic. The AKM 115 is combined with ball valves that have an equal-percentage basic characteristic like the VKR or BKR.

The manual adjustment is performed by releasing the gear unit (slide switch beside the connection cable) and simultaneously turning it with the lever. The actuator position can be determined by looking at the lever or the indicator knob on the top part of the actuator.



Note

After manually adjusting the slide switch, put it back into its original position (engage gear unit).

Intended use

This product is only suitable for the purpose intended by the manufacturer, as described in the "Description of operation" section.

All related product regulations must also be adhered to. Changing or converting the product is not admissible.

Additional technical data

The upper section of the housing with the cover, indicator knob and cover knob contains the stepping motor and the SUT electronics. The lower section of the housing contains the maintenance-free gear unit.

Auxiliary change-over contacts:

- Switch rating max. 230 V VAC, current min. 20 mA at 20 V
- Switch rating max. 4...30 V VDC, current 1...100 mA

Power consumption

Type	Running time [s]	Status	Active power P [W]	Apparent power S [VA]
AKM105SF132	35	Operation	2.45	4.75
		Standstill	0.35	0.8
AKM115SF132	60	Operation	4.9	8.7
		Standstill	0.35	0.75
	120	Operation	2.25	4.3
		Standstill	0.35	0.75

Connection as 2-point actuator

This OPEN/CLOSE activation can be performed via 2 cables. The actuator is connected to the voltage via the blue and brown cables. The control passage of the ball valve is opened by connecting the voltage to the black cable. After this voltage is switched off, the actuator moves to the opposite end position and closes the ball valve.

The unused red and grey wires must not be connected or come into contact with other cables. We recommend that you insulate these.

Connection as 3-point control unit

When voltage is applied to the cable (brown or black), the ball valve is moved to any desired position.

Direction of rotation (viewing the spindle of the ball valve from the actuator):

- The stem turns in the clockwise direction, with voltage on the brown cable, and closes the ball valve.
- The stem turns in the anti-clockwise direction, with the voltage on the black cable.

In the end positions (limit stop in actuator, max. angle of rotation of 95° reached) or in the case of an overload, the electronic motor cut-off is activated (no limit switches). Direction of rotation changed by transposing the connections.

The unused red and grey wires must not be connected or come into contact with other cables. We recommend that you insulate these.

Connection for control voltage 0...10 V

The built-in positioner controls the actuator depending on controller's output signal y.

Direction of rotation (viewing the spindle of the ball valve from the actuator):

Direction of operation 1 (mains power supply on brown cable):

When the positioning signal is increasing, the carrier stem turns in the anti-clockwise direction and opens the control passage of the ball valve.

Direction of operation 2 (mains power supply on black cable):

When the positioning signal is increasing, the carrier stem turns in the clockwise direction and closes the control passage of the ball valve.

The starting point and control span are fixed.

Only the brown cable or the black cable may be connected to the voltage. The cable not used must be insulated (if not connected via switch).

As the starting point and the control span are defined as fixed values, a split-range unit is available (accessory) for setting partial ranges.











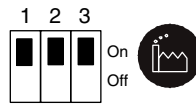
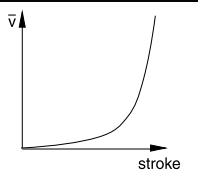
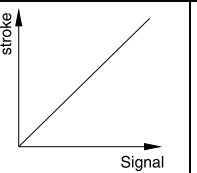
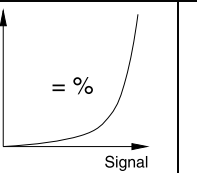
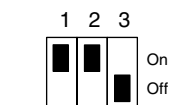
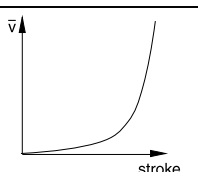
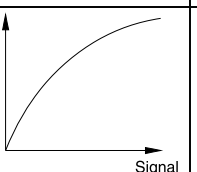
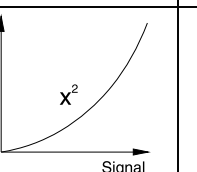

After a manual adjustment or a power failure of more than at least 5 min, the actuator automatically readjusts itself, always with a running time of 60 s.

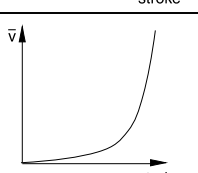
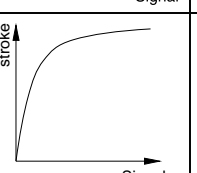
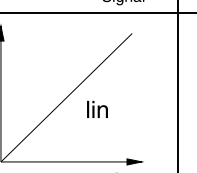
After the power supply is connected, the stepping motor moves to the 100% position, makes the connection with the carrier stem, and then moves to the 0% position and thus defines the working range. After this, every position between a 0 and 90 ° angle of rotation can be achieved, depending on the control voltage. Thanks to the electronics, no steps can be lost, and the actuator does not require periodic re-adjustment. It is possible to operate multiple actuators of the same type in parallel. The feedback signal $y_0 = 0...10\text{ V}$ corresponds to the effective angle of rotation of $0...90\text{ °}$.

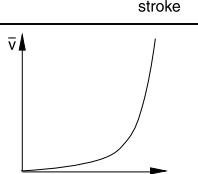
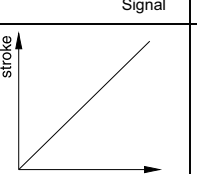
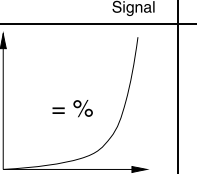
When control signal $0...10\text{ V}$ is interrupted and direction of operation 1 is connected, the ball valve is closed completely (0% position).

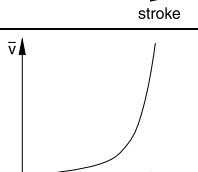
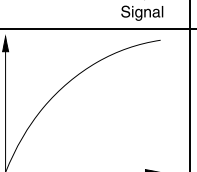
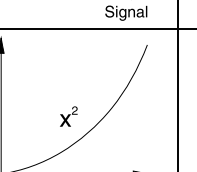
The coding switch can be used to select the characteristic of the ball valve. Characteristics can only be generated when the actuator is used as a continuous actuator. The running times can be selected with additional switch settings. These can be used regardless of whether the 2-point, 3-point or continuous function is selected.

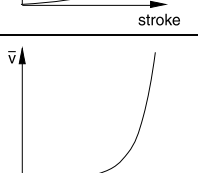
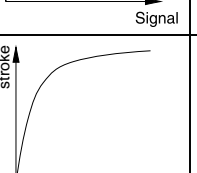
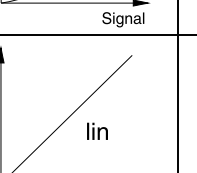
Coding switch for running time and characteristic selection

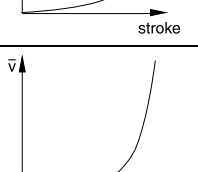
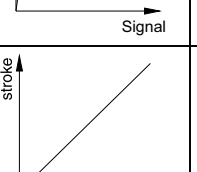
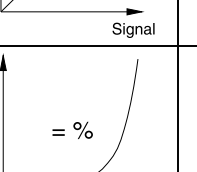
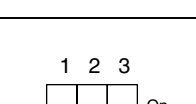
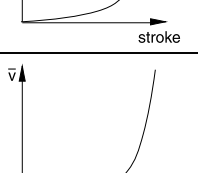
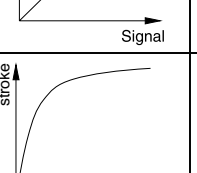
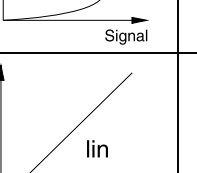
switch position				running time/angle of rotation s/90°
				120 s ± 4
				120 s ± 4
				120 s ± 4
				60 s ± 2
				60 s ± 2
				60 s ± 2
				35 s ± 1
				35 s ± 1

Split-range unit, accessory 0361529 001

Starting point U_0 and control span ΔU can be set with the potentiometer. In this way, several control units can be operated by the control signal in sequence or in cascade. The input signal (partial range)

is amplified into an output signal of 0...10V. This accessory cannot be built into the actuator but must be externally housed in an electrical junction box.

CASE Drives PC Tool, accessory 0372462 001

CASE Drives allows you to set and read the actuator parameters on site. The connection is via a serial port on the PC (laptop) and a socket contact on the actuator. The set consists of: The software including installation and operating manual, fitting instructions, connection plug, cable (1.2 m long) and interface converter for the PC. The application is designed for commissioning and service engineers as well as experienced operators.

The last setting has priority, whether made with the coding switch or CASE Drives. When a change-over is made with the coding switch, this setting is active. In order that the settings made with CASE Drives cannot be overwritten, the coding switch can be removed before the setting (delivery includes special tool).

Notes on engineering and installation

Condensate, dripping water, etc. must be prevented from entering the actuator along the carrier stem. When connecting the electricity supply, ensure that the cross-section of the power cable is adapted to the power output and the length. However, we recommend a minimum cross-section of 0.75 mm².

The actuator/ball valve is mounted by inserting and turning the bayonet ring until the limit stop without any additional adjustment. No tools are required. The coupling of the spindle of the ball valve with the carrier stem is performed automatically, either by moving the manual adjuster to an angle of rotation of 100% or connecting the voltage. For dismantling, the bayonet ring is simply opened and the actuator removed. The device is delivered ex works in the middle position.

The concept of stepping motor and electronics enables parallel operation of multiple actuators of the same SUT type.

If a potentiometer is required, the accessory of the AVM 105, 115 can be used - the display (% angle of rotation) on the type plate is inverted. The maximum accessory equipment for an actuator is 1 auxiliary change-over contact or 1 potentiometer.

The auxiliary change-over contact accessory is screwed onto the top cover of the actuator. To be able to make the mechanical connection, you first have to remove the indicator knob. A new indicator can be seen on the cover of the accessory.

The coding switches are accessible via an opening with a black cover in the housing lid.

Note The housing must not be opened.

Outdoor installation

We recommend protecting the devices from the weather if they are installed outside buildings.

Disposal

When disposing of the product, observe the currently applicable local laws.

More information on materials can be found in the Declaration on materials and the environment for this product.

Connection diagram

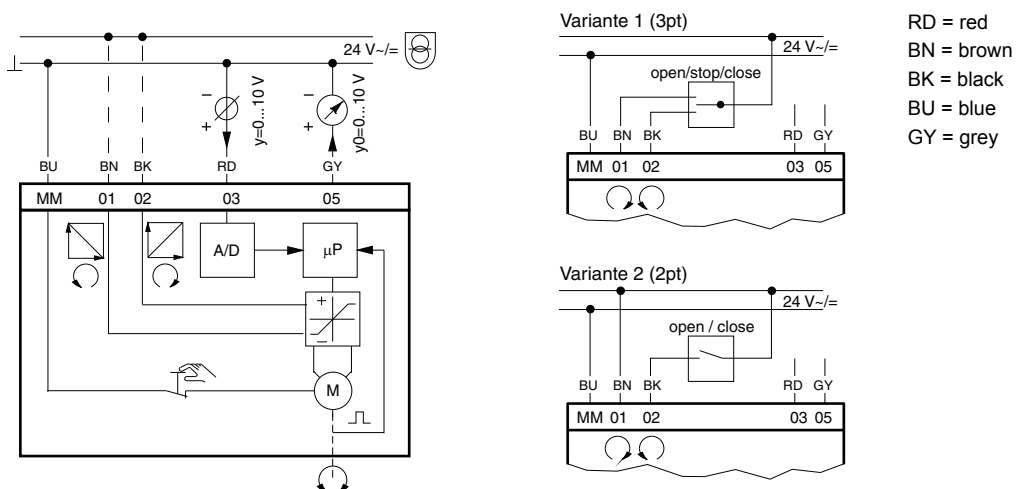

Accessories

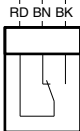
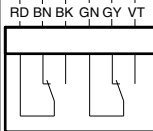
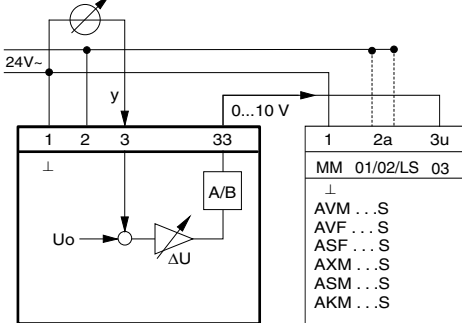
<p>0510480 001</p> 	<p>0510480 002</p>  <p>RD = red BN = brown BK = black GN = green GY = grey VT = violet</p>
<p>0313529</p> 	

Dimension drawing

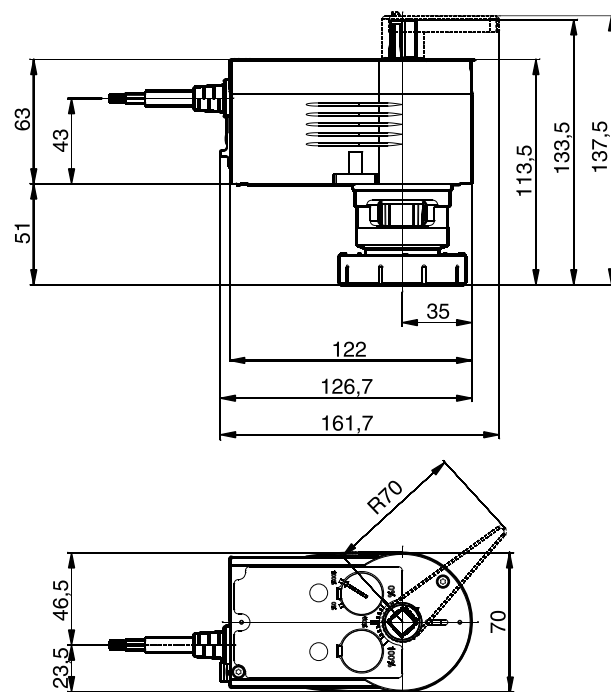

M10483a

Accessories

0510420001

