

EY6AS60: Modular BACnet automation station, modu660-AS

Features

- Part of the SAUTER modulo 6 system family
- Modular automation station, expandable with I/O modules and communication modules
- Regulation, control, monitoring and optimisation of operational systems in HVAC
- Locally expandable with up to 24 modules via the SAUTER Extension Bus
- Can be locally equipped with ecoLink I/O modules and ASV actuators via SLC interface
- Two RJ45 connections switched for daisy chain
- BACnet/IP communication (EN ISO 16484-5)
- REST API interface
- BACnet profile B-BC
- AMEV profile AS-B
- Integrated web server for local commissioning, expandable with visualisation and operation
- User administration for identification, authentication and access control
- Encryption of communication with TLS 1.2
- Bluetooth interface for mobile commissioning and maintenance
- Programming/parameterisation via PC using CASE Suite (based on IEC 61131-3)
- Control libraries
- Time and calendar function
- Predictive control based on meteorological forecast data
- Data recording on removable media (microSD card)
- User administration and user identification (web server)
- Alive signal output pulsed



EY6AS60F011

Technical data

Power supply		
Power supply		24 V = ± 10%
Power consumption ¹⁾		≤ 2 W without load ≤ 24 W at maximum load
Dissipated power		≤ 2 W without load ≤ 4 W at maximum load
Peak inrush current ²⁾		≤ 20 A, ≤ 1 ms on the 24 V side
Parameters		
Connection		5-pin spring-type terminal, pluggable, 0.5...1.5 mm ² (rigid) 0.5...2.5 mm ² , min. 8 mm wire strip- ped
Battery (buffer: RTC)		CR2032, pluggable
Earth connector		Spring contact against DIN rail and PE terminal
Ambient conditions		
Operating temperature		0...45 °C
Storage and transport temperature		-20...70 °C
Ambient humidity		10...90% rh, no condensation
Function		
BACnet data point objects		Up to 800 DP
BACnet client links		300 (Peer-to-Peer)
Control		48 (Loop)
Active COV subscription		2400
Structured view		128 (Structured View)
Dynamic objects		
Sequences, scenes		16 (Command)
Time programmes		64 (Schedule)
Calendar		32 (Calendar)

¹⁾ Maximum load with 12 I/O modules

²⁾ Measured value with EY-PS021F021 power supply unit



	Alarms	32 (Notification Class) intrinsically or extrinsically with Event Enrolment
	Historical data	800 (Trend Log) up to 2 million entries
	BBMD in BDT	32
	FD in FDT	32
Services	Embedded web server	moduWeb Unity
	Notification (client)	SMTP, SMPP
	Time synchronisation	BACnet or NTP
	Data integrity (client)	With modu615-BM
Architecture		
	Processor	ARM Cortex A8, 32 bit, 1 GHz
	RAM (memory)	512 MB (DDR3)
	Flash	512 MB
	Application data	Via CASE Engine
	Operating system	Embedded Linux
	Processes	Supports separated processes with different cycle times and independent booting
	Cycle time	Adjustable via process, min. 50 ms (50, 100, 500, 1000)
Interfaces, communication		
Ethernet network	Ethernet network	2 × RJ45 connector
	10/100 BASE-T(X) switched	10/100 Mbit/s
	Communication protocols	BACnet/IP (DIX), HTTP(S), NTP, SMTP, SMPP
Connection of I/O / COM modules	Use ³⁾	1 × integrated iSEB interface for max. 12 modules, expandable with modu601-LC for max. 24 modules in total
RS-485 B connection	Communication protocol	SLC master
	Use	ecoLink, ASV, ecoUnit, FCCP 200
	Participant	Max. 8 ecoLink modules and 4 ecoUnit modules, max. 12 ASV units
	Power supply	20...26 V=, max. 1.5 W, protected against short circuit, can be switched on/off (CASE Sun)
	Connection	Spring-type terminal, pluggable 0.2...1.5 mm ² stiff/flexible
	Line	4-wire, twisted, shielded
	Line length	Max. 100 m (30 m) with ecoUnit or ASV, up to 500 m, bus termination necessary (120 Ω)
	120 Ω bus termination and pull-up/pull-down	Switchable via software (CASE Sun)
Bluetooth	Version	BLE 4.0
	Range	< 10 m
	Frequency band	2.402...2.480 GHz
	Radiation	6 mW
USB	Version	2.0, type A
	Current limitation	400 to max. 500 mA
SD memory expansion	Type	microSD, suitable for industrial use
Construction		
	Fitting	On metallic DIN rail 35 x 7.5/15 as per EN 60715 Rail housing as per DIN 43880
	Dimensions W x H x D	92.6 (5 HP) x 100.9 x 58.3 mm
	Weight	240 g

³⁾ Performance-dependent

Standards, directives

	Type of protection	Connections: IP00 Front in DIN cut-out: IP30 (EN 60730-1)
	Protection class	I (EN 60730-1)
	Environment class	3K3 (IEC 60721)
	Software class ⁴⁾	A (EN 60730-1, Appendix H)
	Energy class	I to VIII = up to 5% as per EU 811/2013, 2010/30/EU, 2009/125/EC
	BACnet profile	B-BC (ISO 16484-5)
	AMEV profile	AS-B
CE conformity according to	EMC Directive 2014/30/EU	EN 61000-6-1, EN 61000-6-2, EN 61000-6-3, EN 61000-6-4, EN 50491-5-1, EN 50491-5-2, EN 50491-5-3
	Low-Voltage Directive 2014/35/EU	EN 60730-1, EN 60730-2-9, EN 62479
	RoHS Directive 2011/65/EU	EN 50581
	RED Directive 2014/53/EU	EN 300328 (V2.1.1)

Overview of types

Type	Description
EY6AS60F011	Modular BACnet automation station and web server

Accessories

Plug-in I/O modules

Type	Description
EY6IO30F001	modu630-IO 16 × DI/CI inputs I/O module
EY6IO31F001	modu631-IO 8 × UI(DI/CI/AI), 8 × DI/CI I/O module
EY6IO50F001	modu650-IO 6 × relay (2A) outputs I/O module
EY6IO70F001	modu670-IO 8 × DI/CI/DO(OC), 8 × DI/CI I/O module
EY6IO71F001	modu671-IO 8 × AO, 8 × DI/CI I/O module
EY6IO72F001	modu672-IO 4 × AO, 4 × DO(OC), 4 × UI (DI/CI/AI) I/O module (expected to be available in mid-2021)

Connection modules

Type	Description
EY6LC01F001	Module for separate I/O module supply
EY6LC02F001	Coupling kit for I/O modules in cabinet (P100017761 and P100017762)

Function expansions

Type	Description
Y6WS60F009	Data point extension activation code for moduWeb Unity on modu660 AS
Y6WS60F021	Activation code for visualisation on modu660-AS (expected to be available in mid-2021)

Manuals

Document number	Language	Title
D100397589	de	Systembeschreibung SAUTER modulo
D100408512	de	EY-modulo 6 – Best Practice I
D100402674	en	SAUTER modulo system description
D100410201	en	EY-modulo 6 – Best Practice I
D100402676	fr	Description du système SAUTER modulo
D100410203	fr	EY-modulo 6 – Meilleures pratiques I

Description of operation

The modulo 6 system family comprises a series of automation stations and I/O and COM modules for building automation for the BACnet/IP system bus.

The modu660-AS automation station is a modular, freely programmable BACnet Building Controller (B-BC) for the automation of HVAC and room automation applications. The station can also be used for other functions in building automation, e.g. in ventilation systems or for decentralised data preparation for Modbus devices or for the central control of multiple VAV boxes.

⁴⁾ The product is not suitable for safety functions

The integrated moduWeb Unity web server is particularly suitable for small and medium-sized plants.

The web server supports the following activities and functions:

- Commissioning and operation of the station and its attached modules
- Direct visualisation of the data points
- Forwarding of alarms and notifications
- Creation and administration of time profiles (scheduler)
- Creation and administration of calendars (calendar)
- Creation and administration of records (Trend Logs)

With the help of the powerful CASE Suite programming environment and the available function libraries, standard building automation tasks can be carried out and complex projects created with the integration of subsystems via IP/network or field buses.

ecoLink I/O modules, ASV actuators, ecoUnit room operating units and the EnOcean wireless interface can be connected to the automation station via the RS-485 B interface.

The wireless interface can be used to integrate the SAUTER ecoUnit 1 wireless room operating units as well as other standard EnOcean units.

COM modules⁵⁾ can be connected to the station and support integration via the KNX, DALI, SMI, Modbus or MBus interfaces of special actuators, sensors, operating devices or subsystems.

The station can be preconfigured (IP addresses, DOI, names) via the Bluetooth interface and with the SAUTER app.

The historical data records are stored on the microSD card.

Special standards such as IEC 61508, IEC 61511, IEC 61131-1 and IEC 61131-2 were not considered during the development.

Intended use

This product is only suitable for the purpose intended by the manufacturer, as described in the "Description of operation" section.

All related product regulations must also be adhered to. Changing or converting the product is not admissible.

Improper use

The SAUTER modulo 6 system does not have functional safety and is not fail-safe. MTTF, MTBF and MTTR data is not available.

This product is not suitable:

- for safety functions
- in transportation means and storage facilities as per Directive 37/2005
- as a measuring device as per EU Measuring Instruments Directive 2014/32/EU
- in outdoor areas and in rooms with the risk of condensation
- on means of transport, e.g. ships.

Engineering notes

Fitting and power supply

Note



Only qualified electricians are permitted to fit and connect the module. Prevent access by laypersons.

The modu660-AS is mounted in a cabinet using a DIN rail (EN 60715).

You must ensure that it is not installed in the immediate vicinity of power contactors, frequency converters or other EMC interference sources. SAUTER generally recommends installation in a separate DDC cabinet field. During installation, there must also be an external, primary isolating facility. Connection may only be performed when the system is disconnected from the electrical supply. All plant devices are connected via pluggable spring-type terminals. When the power supply is being connected, the protective earth must also be connected to the corresponding terminal (protection class I).

Further recommendations can be found in the document "EY-modulo 6 – Best Practice I".

⁵⁾ Expected to be available from mid-2021

The communication wiring must be carried out professionally and in accordance with the requirements of standards EN 50174-1, EN 50174-2 and EN 50174-3. Communication and plant device wiring must be separated from current-carrying wiring.

Local requirements regarding installation, usage, access, access rights, accident prevention, safety, dismantling and disposal must be taken into account. Furthermore, installation standards such as EN 50178, EN 50310, EN 50110, EN 50274 and EN 61140 must be complied with.

Bus cover

The modu660-AS is supplied with a bus cover. This must be fitted on the right, free side, either on the automation station or on the last I/O or COM module.

Note



The bus cover must always be fitted.

A terminating resistor is installed in the cover to prevent signal reflections and data transmission interference. The cover also protects the spring contacts from short circuits and damage.

Further information on fitting and installation can be found in the fitting instructions for the station.

Alive signal

The alive signal, which monitors the internal processes of the modu660-AS, can be picked up potential-free at terminals 09 and 10. If the system is functioning correctly (power supply, operating system and running watchdog process), the alive output is pulsed at 1 to 5 Hz (adjustable in CASE Sun).

The following should be noted:

- Connection: max. 24 V=, load 10 mA
- No switching against ground (potential-free contacts)
- Solid state relay (no OC)

As a practical application, the alive signal can be forwarded directly to a digital input (CI) of a second automation station or to I/O modules and monitored via software.

Power supply

The device is suitable for operation at 24 V DC. Operation with EY-PS 021 switched-mode power supply is recommended as it is optimally matched to the modu660-AS. It is necessary to use a double-insulated power supply.

DC operation has the lowest power loss and heat generation. This prolongs the serviceable life and minimises the device's own consumption.

The maximum ampacity of the connection terminals must be complied with; to this end, external fuse protection is essential in all cases. When a current-limiting power supply unit is used, such as EY-PS 021, fuse protection in the 24 V electrical circuit is not necessary. The fuse required for the primary electrical circuit on the power supply unit can be found in the manufacturer's instructions.

For the sizing of a DC power supply, the maximum current consumption of the modu660-AS and all other devices connected to the 24 V supply is added up. The next-largest power supply module is selected; a reserve of at least 15% is to be taken into account.

Note



Some field devices (e.g. AXS continuous thermal actuator) and the remote ecoLink 510, 511, 512* I/O modules require a 24 V AC power supply. The remote ecoLink 514, 515 I/O modules can also be supplied with a 24 V DC power supply. However, this must not be the same supply source as that for the station.









Earth

The earth connector on the modu660-AS is the protective earth and must always be connected to the earth for safety and EMC reasons.

Earthing is exclusively at the earthing terminals of the modu6 devices. Signal ground terminals must not be earthed. MM and conductors of the 24 V power supply units must not be earthed.

LED indicator of the station

The following operating statuses of the automation station are displayed:

Status ⁶⁾	Indicator	Description
Continuous green		Normal mode
Flashing green		Identification via CASE Sun
Continuous orange		Startup mode ⁷⁾
Flashing orange		The internal backup battery must be replaced
Continuous red		No CASE Engine plan in the station
Flashing red		Program download or configuration active
Red flashing rapidly		Internal device error
Off→Green→Red		LED test sequence

Programming and parameterisation

The complete user program (Engine Plan) and the different parameterisations (BACnet objects, images for moduWeb Unity, etc.) are created using CASE Suite. Up to 800 BACnet data points incl. hardware inputs and outputs can be used.

Every station must be configured for communication in an Ethernet network. All settings such as IP address, subnet mask, gateway and instance number (DOI) are parameterised via CASE Suite. Automatic configuration via DHCP servers is also possible.

To be able to visually identify the modu660-AS in a network, the CASE Sun commissioning tool can be used to put the run/fault LED in flashing mode.

The modu660-AS contains a fast operating program. This reads all inputs, processes the parameterised function modules, updates the outputs and handles the necessary communication with other stations or the management level (PC).

The user program can be loaded from any point in the IP network with CASE Suite. Flashing red LED indicators show that there is an active download. The data is written to a flash memory and is retained even if there is a power failure.

The inputs and outputs can be parameterised by the user program and used freely for control and regulation tasks.

Initialisation

An initialisation of the modu660-AS can be carried out before the download with CASE Suite.

Firmware/update

The modu660-AS is delivered with the latest firmware. If a firmware update is available during commissioning, it can be installed directly via the network with CASE Suite. When an update is active, the LED indicator flashes red.



Note

Only operate the modu660-AS with the latest firmware. Before commissioning, check the firmware version and carry out an update if necessary.

The version of the installed firmware can be read via CASE Suite.

moduWeb Unity

The embedded moduWeb Unity web server is available ex works for configuring the automation station ("System" menu item), e.g.:

⁶⁾ LED flashing: 500 ms on, 500 ms off

LED flashing rapidly: 100 ms on, 100 ms off

LED test sequence: 1 second off > 1 second green > 1 second red

⁷⁾ During the startup process, it lights up red briefly, then green and then orange again.

- User administration
- IP settings
- Security settings
- Licensing
- Various system information

The functionality can be extended with activation code Y6WS60F021. The moduWeb Unity can be used as an operating platform for the BACnet controller, with the functions of a local management system:

- Operation of the local plant
- Access to the BACnet objects
- Alarm lists and alarm notification via email and/or SMS
- Display of historical data
- Image dynamisation (if created with CASE)

Technical data for moduWeb Unity

I/O mix	Y6WS60F021	Y6WS60F009
BACnet objects	500	1600
Historical data points (via spontaneous message)	400	400
Historical data points (polled)	50	50
Memory for project data	60 MB	60 MB
Data points per chart	1-6	1-6
Charts	100	100
Images	75	250
User accounts	25	100
Registered users	5	25
Number of stations	1	1

Internal clock

A Real Time Clock (RTC) is integrated into the station for the time programmes. The date, time and time zone are set in the station when loading the user parameters.

The BACnet services “DM-TS-B” and “DM-UTC-B” are used to synchronise the time and date automatically if a BACnet time server is specified accordingly (e.g. SAUTER Vision Center). The station itself can also serve as a BACnet time server (“DM-ATS-A” service). Alternatively, the clock can be synchronised with the NTP service. The setting is made in CASE Engine.

The summer time setting (daylight saving) is activated in the network properties of the station (CASE Engine) by default and includes all the automation stations integrated in the same network. If there is a deviation with regard to the European summer time regulation, the switchover date can be adapted to local conditions.

Time programmes, calendar

The BACnet functionality allows up to 64 time programme objects (scheduler) and up to 32 calendar objects (calendar) to be created in the station.

The integrated web server can be used to display, operate or adjust the time programme or calendar objects.

Battery

A lithium battery (pluggable button cell) ensures that the Real Time Clock for time programmes (scheduler/calendar) keeps running in the event of a power failure.

The battery voltage is monitored by the station and can be monitored by a programme using the “BAT_ST” module. If necessary, an alarm notification can be generated.

The battery may only be replaced when the automation station is disconnected from the power supply. During battery replacement, the current time of the internal clock is lost and must be reset.

Follow the safety instructions and the directions in the fitting instructions for the station. If necessary, contact SAUTER Service to replace the battery.

Technical data for the battery

Type (standard)	CR2032 lithium button-cell
Nominal voltage	3 V

Capacity	210 mAh
Dimensions	20 mm × 3.2 mm

The lithium battery should be replaced after five to ten years. It may only be replaced by trained specialist personnel.

**IMPORTANT!**

Risk of explosion if the battery is short-circuited during replacement.

- ▶ Only use insulated tools when replacing the battery.

The user data from CASE Engine and modified user data (e.g. modified by BACnet client) is permanently stored in the flash memory and does not require a battery buffer.

However, to prevent data loss it is recommended to secure the user data and any changed user data via a backup (e.g. BACnet DM BR).

Behaviour in case of mains failure

During mains interruptions, the station is switched off in the correct manner. When the power returns, the system is switched back on according to priority. The behaviour for switching off and on is defined autonomously by the station.

The following applies to BACnet objects and functions here:

- Every restart can be announced with a restart notification ("DM-R-A" service).
- The "Notification Class Recipient List" remains and the clients still automatically receive the event and alarm information without logging in again.
- The COV subscriptions on other stations are logged in again automatically.
- Connections between the integrated automation stations are updated (re-subscription). When the power returns, the station checks the consistency of the data and automatically restarts the communication.

**Note**

Power failures in the EY-PS021 switched-mode power supply on the primary side (230 V~) that last less than 100 ms are bridged without switching off or other consequences. The system continues to run in normal mode.

If the power supply from a modu601-LC is interrupted, which changes the integrity of the I/O bus, the I/O bus is resynchronised. The modules that can still be reached by the station are out of operation for about 5 seconds, and are then back in operation. This happens in the event of a power failure and when power is restored. After the power returns, all modules should be operational.

When a station is restarted, it is essential for the power supply to the modu601-LC to be already present.

Extension options

To extend the base station, additional I/O or communication modules can be used. The modules are arranged directly on the right-hand side of the station and are thus connected via the I/O bus spring contacts.

The station automatically detects the connected modules on the I/O bus. The module attribution and the allocation of inputs and outputs must additionally be carried out by the CASE Suite software in the station.

The number of locally pluggable modules is limited to 24. Up to two additional lines can be created using the modu602-LC coupling kit.

A modu601-LC must be used to supply power to more than 12 modules or to supply power to the I/O modules separately from the automation station.

The termination board supplied with the station must be placed on the last module.

Up to five COM modules (modu6**CM) can be used per station. The COM modules must be used at positions 1 to 5.

**IMPORTANT!**

Destruction of electronics!

- ▶ Add or remove I/O modules only when the station is disconnected from the power supply.
- ▶ The current loading of maximum 1300 mA for the station must not be exceeded. This must be ensured in advance during the engineering.

The maximum current loading is the sum of all the connected devices incl. the I/O modules and operating units.

The information on the current consumption of the individual I/O modules and operating and indicating units can be found on the respective product data sheets.

RS-485 B interface

The interface is used to connect the following devices:

- I/O modules of the ecoLink family
- Room operating units of the ecoUnit 3 series
- ASV actuators
- EnOcean wireless interface
- FCCP 200 operating device

The maximum bus length depends on the cable type used and the correct termination with terminating resistors. In general, a 4-wire shielded cable with twisted wire pairs must be used. Observe the correct polarity of all signals. The cable shield of the entire bus line must be connected at all points. On the station side, the cable shield must be connected to the protective earth on one side and as directly as possible. The cable length between the protective earth terminal and the cable shield must not exceed 8 cm in order to achieve optimum interference immunity.

For Ethernet CAT 5 cables and J-Y(ST)Y cables, the possible bus length is up to 500 m. The bus length is reduced when wireless interface units or EY-RU 3** room operating units are connected (see connection plans). In the case of RS-485 interfaces, the bus wiring must follow line topology. Star, tree or branch topologies are not recommended. The modu660-AS has built-in resistors that are activated/deactivated via software. When they are activated, a terminating resistor at the start of the bus can be omitted.

The RS-485 B interface is equipped with a 24 V output with maximum 1.5 W power for the supply of the connected modules. The 24 V output can be switched on or off with CASE Sun.

Possible combinations of devices on an SLC bus line:

	Max.	Combination options				
ASV2*5BF1**	12	12	8	4	8	6
EY-RU3**	4	-	4	4	-	-
FCCP 200	4	-	-	-	-	4
ecoLink module	8	-	-	4	4	2
Total RS-485 channel	12	12	12	12	12	12

 See the data sheet of the individual SLC device for any limitations.

Activating terminal and bias resistors (PU/PD) is generally recommended. The terminal resistor is especially important for longer bus lines and/or higher baud rates. If the station is at one end of the bus, the resistor built into the station can be activated with CASE Sun. Activating the built-in PU/PD resistors is particularly recommended if any of the participants are not fail-safe. Both PU/PD resistors can also be activated with CASE Sun.

IMPORTANT!



Damage to the electronics!

▶ Do not connect older SLC devices that are supplied with 5 V to a 24 V power supply unit.





Start-up behaviour / monitoring function

The communication between the station and the engineered ecoLink modules on the RS-485 bus is monitored. If the communication fails for longer than the 10 second monitoring time, the affected ecoLink modules switch to the safety status. The data points in the station are marked with the status "unreliable". All outputs of the affected ecoLink modules are switched to the defined value for the safety state.

Engineered room operating units are also monitored. The status of the devices is displayed via corresponding "Valid" outputs on the ROOM_UNIT block in CASE Engine.

For details on start-up behaviour and monitoring functions, see the documentation of the respective peripheral devices.

LED indicator of the RS-485 B interface

Status ⁸⁾	Indicator	Description
Continuous green		OK, normal operation
Flashing green		Network traffic
Continuous orange		Start-up mode, communication is being set up
Flashing red		Communication error (e.g. ecoLink not connected)
Off		Interface not used, no communication

BACnet mapping

BACnet objects	Description
BI, BO, BV	1-bit binary
AI, AO, AV	32-bit float (analogue)
MI, MO, MV	32-bit unsigned integer (multi-state, 1...8 levels)
PIV	32-bit unsigned integer (positive integer)
PC	32-bit unsigned integer (pulse counter)
LO	32-bit float (lighting output)
TL	TrendLog
EL	EventLog
EE	EventEnrollment
SCHEDULER	Planner
CALENDAR	Calendar
LOOP	Control loop

Meteorological forecast data

The station can obtain weather forecast data (temperature (min., max.), hours of sunshine, global radiation, amount of precipitation, rel. humidity, wind speed and direction) for energy-efficient and proactive regulation via a constant internet connection, directly and without additional components.

Local operation (web server, SAUTER app)

The station can display its configuration status on a compatible mobile device with the SAUTER app via the Bluetooth interface. In addition, an IP network-capable device can visualise and operate the configuration and a customer-specific plant display via a web browser that supports standard HTML5. The plant display can contain the following dynamic objects:

- Alarm lists of the plant
- Setting options for schedules
- Calendar
- Records or historical data
- Preparation of reports with the listed content

Note



The local operating level of the product is not suitable as an emergency operating level according to Machine Directive 2006/42/EU. Standard EN ISO 13849-1 has not been considered. If applicable, a local emergency operating device must be installed on the plant side.

Access security



IMPORTANT!

Priority operating units can lose their priority function.

- ▶ Limit the access to the local operating level (incl. via apps) on site.
- ▶ Consider the access security during the planning and risk assessment of the plant.

⁸⁾ LED flashing: 500 ms on, 500 ms off

Channel and terminal assignment

	Description	Terminal
RS-485 B (4-pin spring-loaded plug-in connector)	D-	05
	D+	06
	C (Common)	07
	24 V= (out)	08
Alive signal, 1...5 Hz adjustable (potential-free contact)	A-	09
	A+	10
Power supply	PE (functional earth)	11
	24 V-	12
	24 V+	13

Note



Pay attention to the different supply voltages at the RS-485 B interface when combining with the modu60 predecessor system. For the ecos504/505 room automation station it is only 5 V= ± 5%.

Protection mechanisms at application level

The modu660-AS has the following protection mechanisms:

Process manager

Productive processes take precedence over other processes, such as web server communication or BT interfaces. The control processes of the building automation are always a priority.

Access rights

Access to the web server and the API and BT interfaces is protected by user name and password. The first time a user logs in to the web server, the default password must be changed. The user administration and the setting of the access rights are the responsibility of the system operator. An auto-logout or the duration of a login can be set up.

The physical USB, LAN and SD interfaces can be activated or deactivated by authorised users with CASE Sun or via the web server.

Functional safety

The modu6 product series is not suitable for plants or applications that require functional safety (software class A). The modu6 products do not have an SIL class and are not fail-safe.

Data security

User data is stored in encrypted form.

Together with a Building Data Integrity Manager (e.g. modu615-BM), the integrity of the project data is periodically checked using patented blockchain technology.

Communication security

Internet communication is encrypted where technically possible. The HTTPS and SMTP protocols, for example, are encrypted. When BACnet Secure Connect is being used only encrypted communication is possible.

The system only allows communication via authorised ports. All other ports are blocked by the on-board firewall. In addition, an authorisation list with approved devices can be created.

Firmware update

Only firmware updates signed by SAUTER can be installed.

Disposal

When disposing of the product, observe the currently applicable local laws.

More information on materials can be found in the Declaration on materials and the environment for this product.

Connection diagram

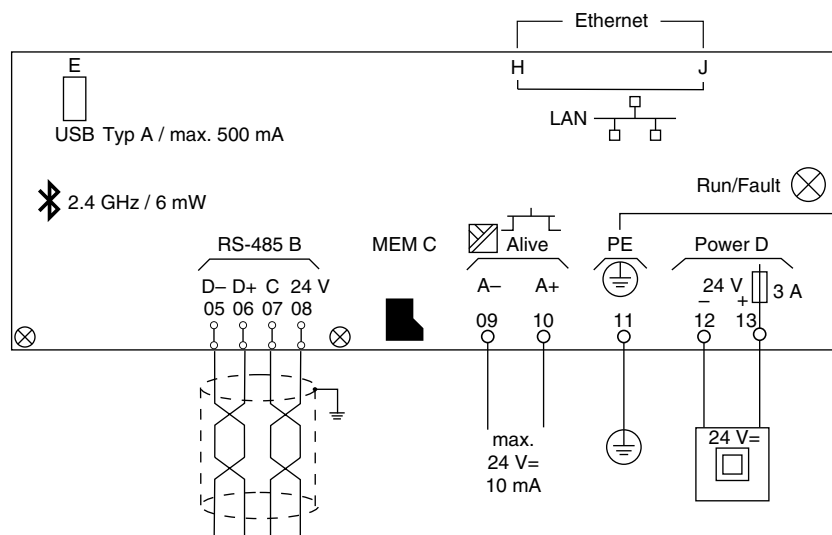

Bus wiring

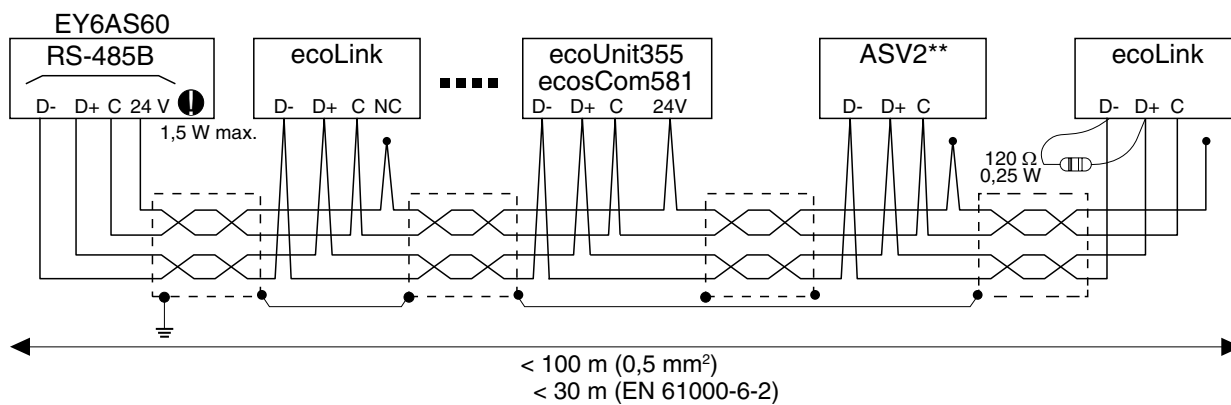
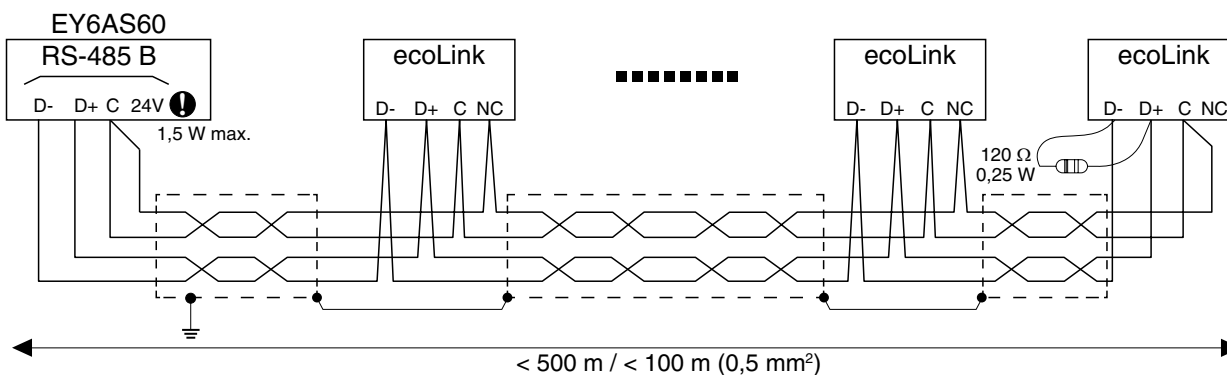

Dimension drawing

All dimensions in millimetres.

